

Atlas

User Manual

V. 5.001

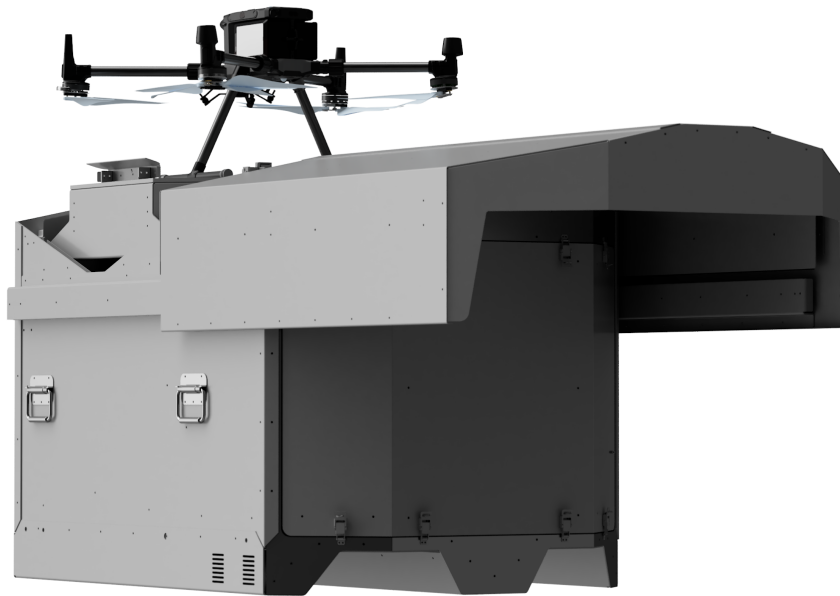

Table of Contents

| | |
|---|------------|
| Introduction and Support | 3 |
| Applications | 4 |
| Safety | 6 |
| Regulatory Training | 7 |
| Specifications | 9 |
| Externals Box Specifications | 10 |
| Station Components & Features | 11 |
| Technical Specifications | 25 |
| Wiring Diagram | 26 |
| Installation | 27 |
| Unboxing and Placement | 28 |
| Initial Setup | 28 |
| Battery Placement | 31 |
| Hardware & Software Inspection | 32 |
| Operation limitations & Emergency Procedures | 35 |
| Navigating the Dashboard | 39 |
| Station Calibration: Instructions | 52 |
| Station Calibration: Flow Chart | 65 |
| Station Calibration: Swap Logic Diagram | 68 |
| FlytNow Operations | 71 |
| Create a FlytNow Account | 71 |
| Pre/Post flight Inspection | 71 |
| Registering Drone Station | 72 |
| Linking Drone | 74 |
| Cloud Media Sync | 76 |
| How To Create Missions | 81 |
| How To Fly | 85 |
| Maintenance | 88 |
| Maintenance Introduction | 89 |
| Station Maintenance | 90 |
| Maintenance Schedule | 93 |
| Drone Maintenance | 95 |
| HVAC LED Code Troubleshooting | 97 |
| Station Battery Rack Lights/Sound Indicators | 98 |
| Troubleshooting & Repair | 100 |
| Troubleshooting: Hardware/Software | 101 |
| Warranty | 102 |
| Conclusion | 105 |

Introduction and Support

Welcome to the Hextronics Atlas User Manual. At Hextronics, our goal is to enable aerial autonomy and we believe that the Hextronics ATLAS Drone Station is a significant step towards achieving that goal.

This manual has been created to provide you with all the necessary information to install, operate and maintain your Hextronics ATLAS station. We want to ensure that you can use our product successfully and achieve your goals of aerial autonomy.

If you have any technical or support related questions, please do not hesitate to contact us at Support@Hextronics.tech. Our team of experts is available to assist you and ensure that your experience with the Hextronics ATLAS Drone Station is nothing short of exceptional.

Thank you for choosing Hextronics ATLAS Drone Station. We are honored to have the opportunity to be a part of your journey towards aerial autonomy.

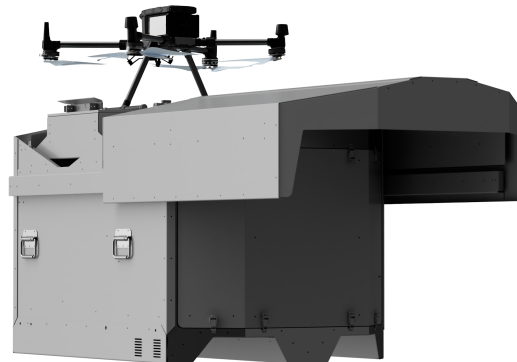

This manual contains the necessary information and procedures for the safe operation and maintenance of the ATLAS M300 unit. To ensure your safety and prevent physical injury, it is essential that you carefully read, comprehend, and adhere to the safety instructions outlined in this manual. It is recommended that you keep a copy of this manual with the unit at all times. Additional copies are available from Hextronics or can be accessed via the website, Hextronics.tech.

It should be noted that the information provided in this manual is based on machines currently in production. Hextronics reserves the right to modify any portion of this information without prior notification. We advise you to read all manuals that come with the unit, as they contain specific details regarding setup, usage, and servicing requirements.

In particular, the Charging Dock manual provides comprehensive guidelines for the operation and maintenance of the dock. Additional copies of the charging dock manual can be obtained from the manufacturer.

It is important to emphasize that this equipment should not be modified or used for any application other than that for which it was designed. Only a licensed and trained electrician should perform wiring and connections to the unit, with all wiring being compliant with National Electrical Code (NEC), state and local regulations, as well as Occupational Safety and Health Administration (OSHA) guidelines.

Applications

Security

Traditional surveillance methods require security guards to be present 24/7 and proactively conduct patrols. Our unique drone station swaps the drone's battery, ensuring minimal downtime and immediate response under any circumstances. The system paired with the automated flight control software enhances effectiveness and collaboration and reduces operational costs significantly.

- Round-the-Clock (24x7) Patrols
- Live Situational Awareness
- Incident Response
- Third-party alarm integration
- Intruder Detection

Agriculture

Drones have revolutionized agriculture by offering cost-saving analogies and enhanced efficiency. Drones can do anything from precision agriculture to monitoring field activities. It provides high-resolution data for crop analysis and 3D mapping promptly and accurately. Our systems allow farmers to conduct scheduled missions from anywhere in the world, allowing them flexibility and proficiency.

- Plant health monitoring
- Reduced operations cost
- 3D Mapping
- Farm activity monitoring

Engineering & Construction

Current inspection methods are dangerous and inefficient. Automated drone stations are easy to operate and provide project/construction managers with accurate and high-resolution data faster. It reduces operational costs, enhances team alignment and collaboration, and ensures worker safety.

- Progress tracking
- Change detection
- Hazards & fault identification
- Equipment surveillance
- Site mapping & inspection
- Ensure crew safety
- Aerial and 360 degree view

Law Enforcement

When it comes to saving lives, 30-60 seconds can make a difference. Adopting an autonomous drone system allows immediate response, enhances officer safety, and provides a live video of the situation to the authorities to prepare an effective response.

- Event/crowd monitoring
- Surveillance
- Crime scene analysis
- Search and rescue
- Traffic control
- Collision investigation
- Suspect tracking

Disaster Response

The first 72 hours after a natural disaster is highly critical. As first responders work to save lives and minimize damage, they rely on accurate geographic information to coordinate operations. The more information officials have on the impacted areas, the more effective their response is. Because drones can be quickly deployed over disaster zones, responders can use them to produce 3D maps, search for victims and assess damaged infrastructure.

- Damage detection & analysis
- Rescue & Response
- Site Visibility Enhancement
- Unsafe Area Access
- Food and Medical supply delivery
- Complete Situational Awareness (360-degree coverage)

Asset Inspection

Various industries employ drones for visual inspections as maintenance procedures. A few industries adopting drone technology are Gas and Pipeline, Mining, Energy (Solar PV, Wind turbines, Dams), ports and terminals, etc. Utilizing a drone to collect visual data on an asset's condition decreases operational costs and ensures the inspector's lives are not in danger.

- Power line inspections
- Solar panel inspections
- Railway track maintenance
- Roof maintenance and inspection

Safety

Drones have become increasingly popular in recent years, with more and more people owning and operating these unmanned aerial vehicles. While drones can be fun and useful tools, it's important to prioritize safety and follow FAA rules and regulations to avoid potential risks and hazards.

One of the most important reasons to adhere to FAA rules is to prevent collisions with other aircraft. This can include airplanes, helicopters, and even other drones. Collisions can cause serious damage and potentially harm individuals on the ground or in the air. By following the FAA's guidelines for operating drones, pilots can help to prevent these dangerous situations. In addition to collision prevention, adhering to FAA rules can help protect individuals on the ground. Drones can fly at high altitudes and at high speeds, which can make them dangerous if not operated responsibly. By following guidelines for flight altitude, distance from people and buildings, and other safety measures, drone pilots can minimize the risk of injuring others.

It's also important to remember that flying a drone irresponsibly can result in legal consequences. The FAA has regulations in place to ensure the safety of individuals and property, and violating these rules can lead to fines or even criminal charges.

Ultimately, prioritizing drone safety is crucial for both the drone pilot and those around them. By following FAA rules and regulations, pilots can help prevent collisions, protect individuals on the ground, and avoid legal consequences. So, if you're a drone owner or operator, make sure to educate yourself on the FAA guidelines and prioritize safety in all your flights.

Please visit <https://www.faa.gov/uas> for more information on UAV safety and certifications.

Regulatory Training

Please contact support@hextronics.tech for all regulatory training needs.

As of the current version of this document, Hextronics has three classes of certification that an individual can obtain to oversee the deployment, operation, and maintenance of an Atlas 300 Drone Nest system. They are outlined as follows:

- Certified Operator
- Certified Technician
- Certified Instructor

Operations of scheduled or unscheduled drone flights/missions shall be conducted or overseen by a certified operator. Maintenance and preventative measures over the lifetime of the drone station shall be conducted by a certified technician. Note that a single individual can receive both certifications for both the operation and maintenance of the drone station. Official certification of other individuals can only be conducted by certified Instructors.

Certified Operator

- A certified operator is an individual who has obtained the relevant certifications for piloting a DJI Matric 300 Drone remotely in accordance to their local regulatory certification procedures; for example, obtaining a FAA Part 107 Remote Pilot Certificate, as well as completing the Hextronics Operator training with a certified instructor.
- Training will be conducted with the drone station present with at least one party. Operator training will cover the following categories: Installation and setup of the Atlas300 Drone Station Basic Flight operations and mission planning with the DJI M300 and Atlas300 Operating Limitations and Emergency Procedures Pre-flight and post-flight inspections Basic hardware and maintenance

Certified Technician

- A certified Technician is an individual who has completed the Hextronics Technician training, conducted by a certified Instructor.
- Training will be conducted with the drone station present with at least one party. Operator training will cover the following categories: Installation and setup of the Atlas300 Drone Station Advanced Operational adjustments Procedures for routine / preventative maintenance inspections to be conducted in the field

Certified Instructor

- Instructor certification can only be obtained after three months, or 100 missions of use with the Atlas300 Drone station, and the individual must have completed the prior Hextronics operator and technician training of the Drone Station.
- A certified instructor will have a deep level of knowledge of the entire drone station, and can only be certified by another instructor.
- The certified instructor shall have training in all parts of the user manual, as well as an understanding of how to identify and solve any unforeseen issues with the drone station.

Specifications

This section describes the specifications of the Atlas

Externals Box Specifications



Complete Externals System

Properties

- Externals Box Dimensions LxWxH: 11.2 x 7.7 x 5.1 Inches
- Max Weight: 7lbs || 3.17Kg
- Exterior Temperature Range: -20°C to 50°C || -5°F to 120°F
- Internal Regulated Temperature: 10°F to 35°C || 50°F to 95°F
- Radio Frequencies: 2.4 GHz - 5.0 GHz

Input/Output Properties

- Input Power: 12V DC
- Max Power Consumption: 50W
- Drone Station Communication: USB 3.0
- Cooling System: 12v thermoelectric cooling system

Major BOM components

- 12V Electrical Solenoid
- 48850 Heavy Duty Gooseneck Stabilizer Tripod
- 12V Thermo-electric cooling system

Station Components & Features

The Hextronics Atlas Drone Station is designed and intended to be used in combination with the DJI Matrice 300 drone for drone housing & deployment, and battery swapping & charging.

General Overview: Atlas Drone Station



Compatible Aircraft:

DJI Matrice 300

Drone attachments vary

A. Handles/ Steel Rings/ Forklift Access

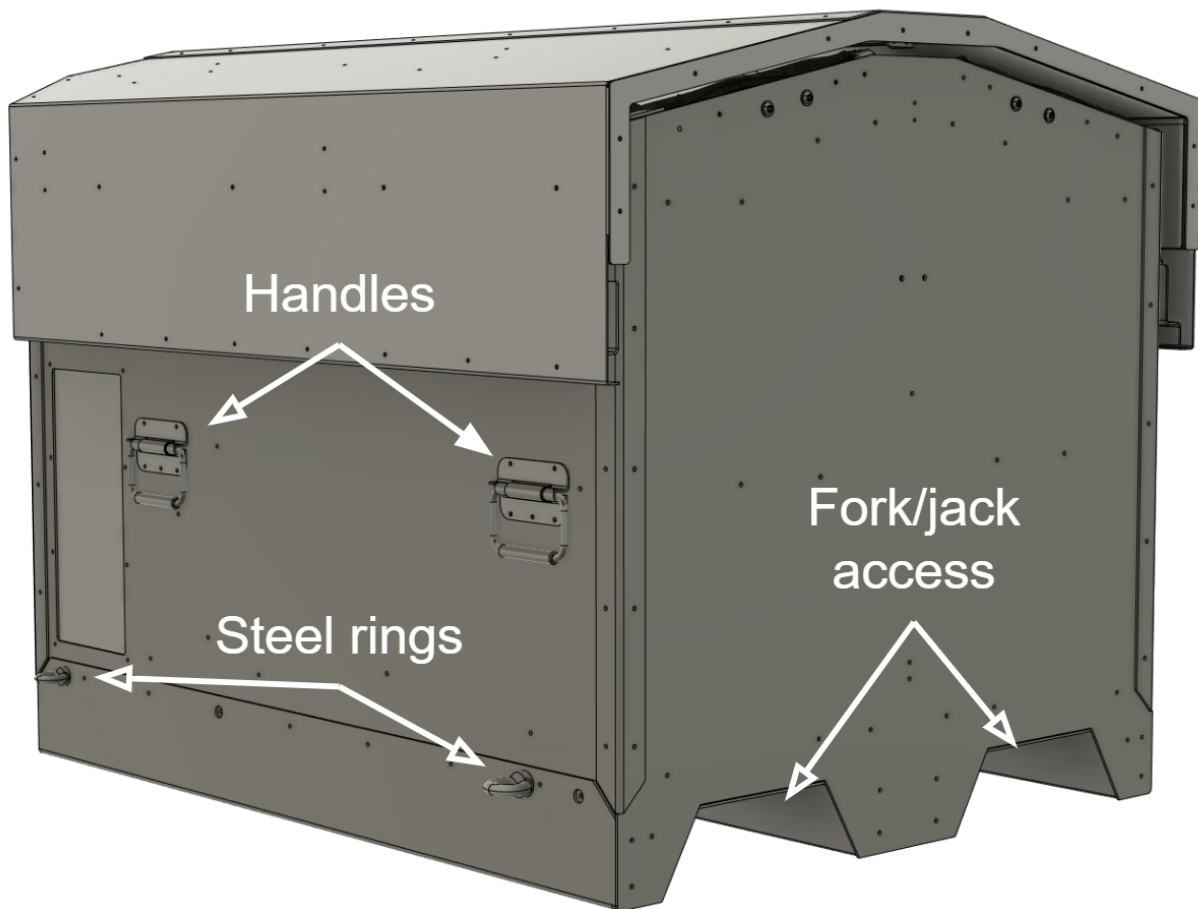

Handles: 500 lbs weight capacity each for manual four-person lifting.

Steel rings: 500 lbs weight capacity each for hoisting.

Forklift access: For forked machine lifting and transportation.

B. Outdoor Weather Seal

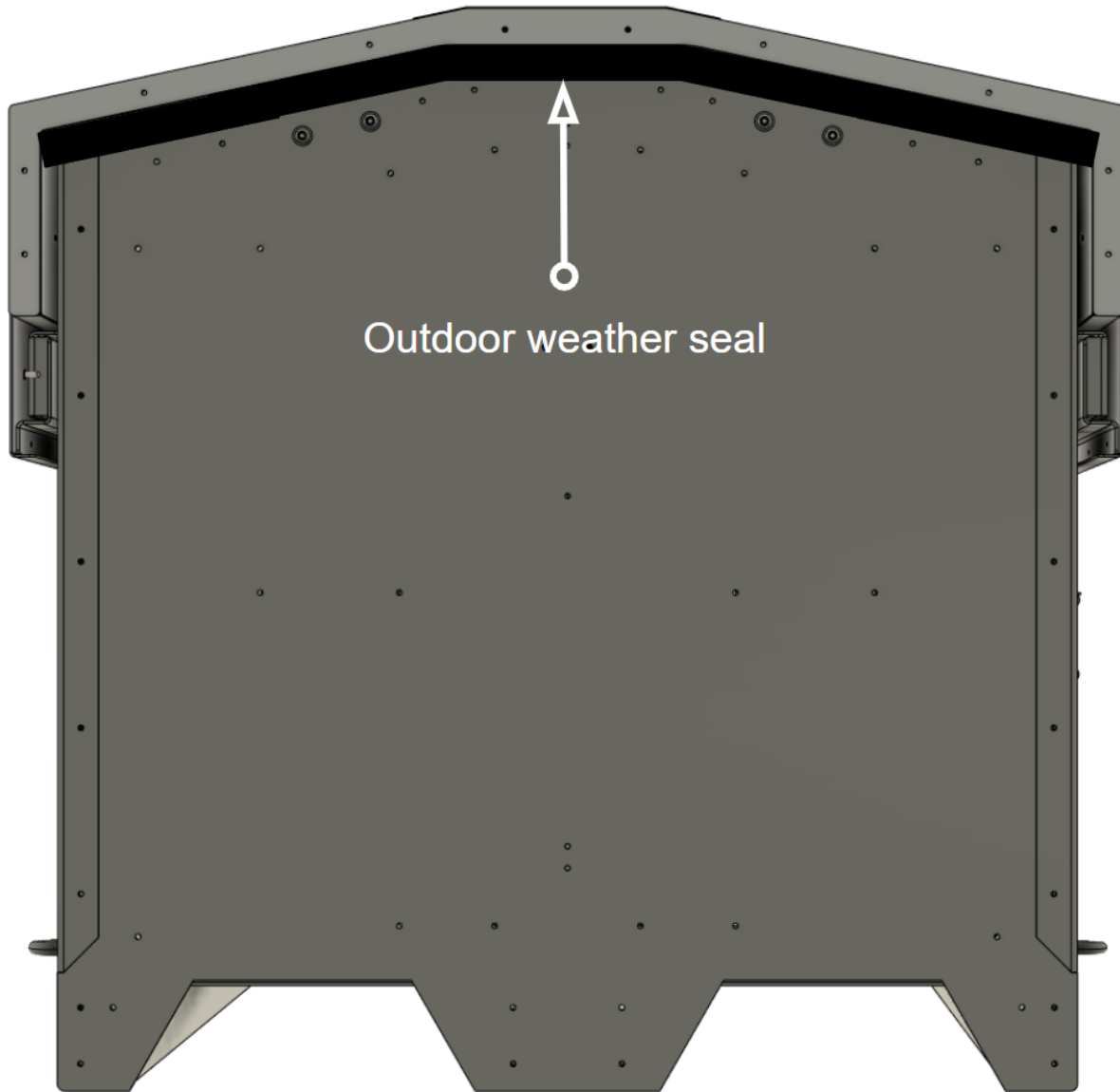

Outdoor weather seal: A rubber seal encases the entity of the station to protect it from outdoor elements such as rain and dust.

C. Actuating Roof

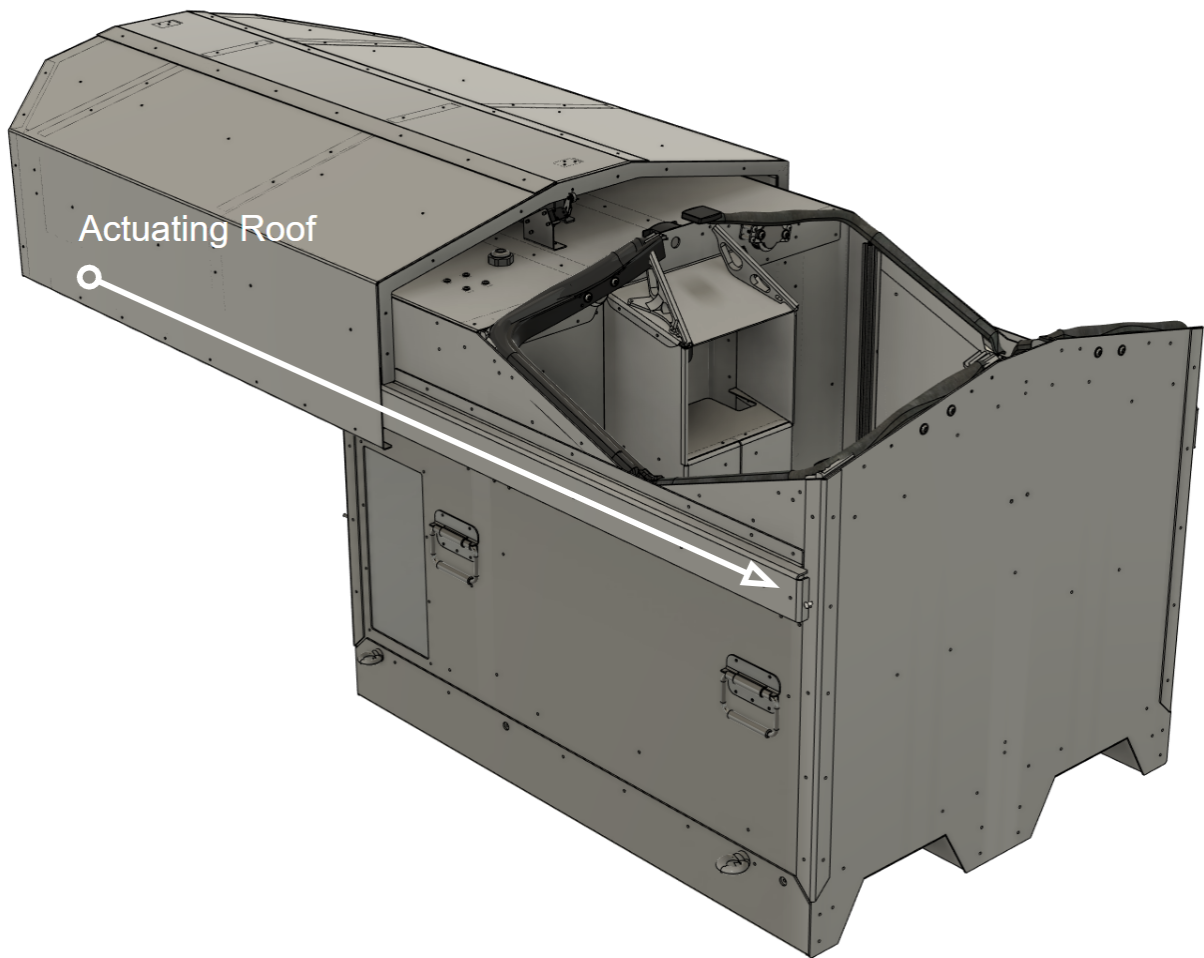

Actuating roof: Powered by DC motor to actuate roof opening/closing.

D. Roof Motor/ Internal Cameras/ Roof Switches

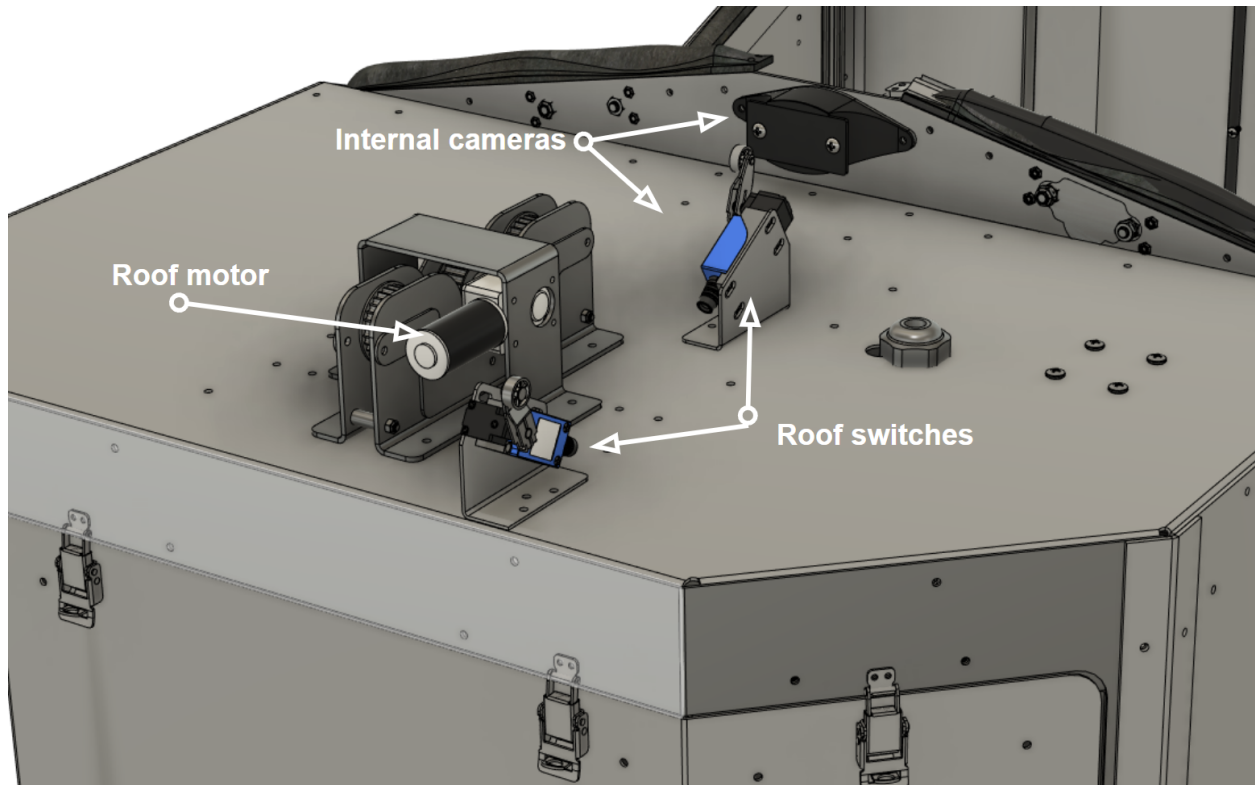

Roof motor: Powered by DC motor to actuate roof opening/closing.

Roof switches: Limit switches for roof actuation

Internal cameras: Accessible via web browser for surveillance & monitoring. (Interior camera not shown)

E. Landing Pad / Drone Sensors

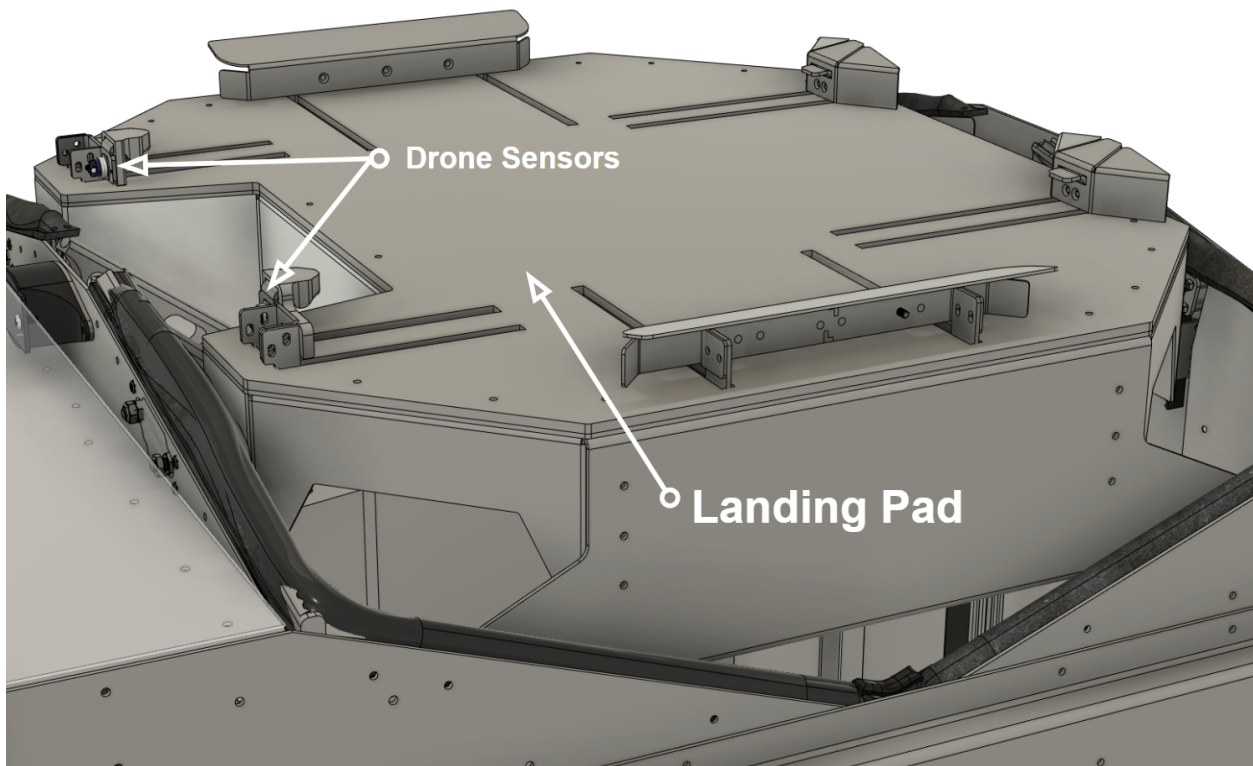

Landing pad: Used for landing and take-off of the drone as well as centering and latching the drone into the proper position for station operations.

Drone sensors: Senses when the drone has successfully centered.

F. Actuating Landing Pad/ Gantry¹

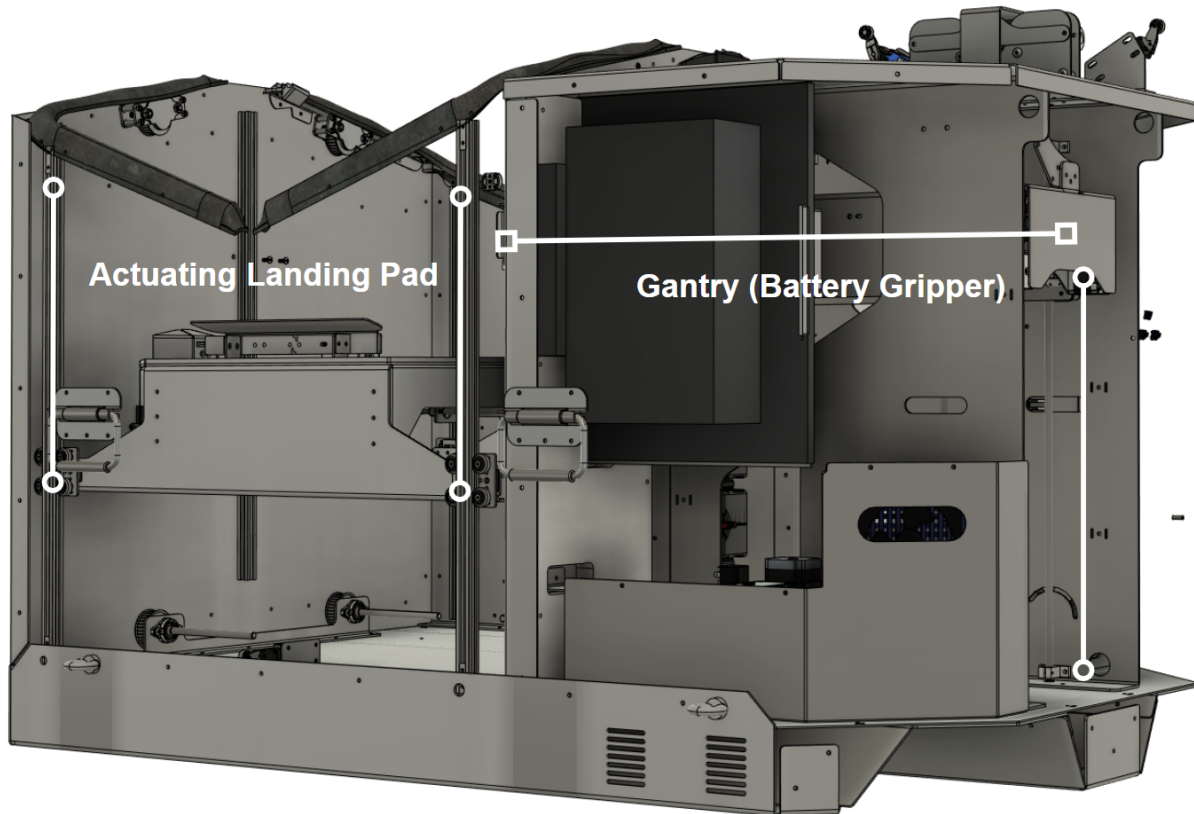

Actuating landing pad: Used for landing and take-off of the drone, moves on a Z-axis

Gantry: Used to remove/insert batteries from the drone

¹ Gantry = Battery Gripper

G. Latch Lock/ Power Button Cycle Arm

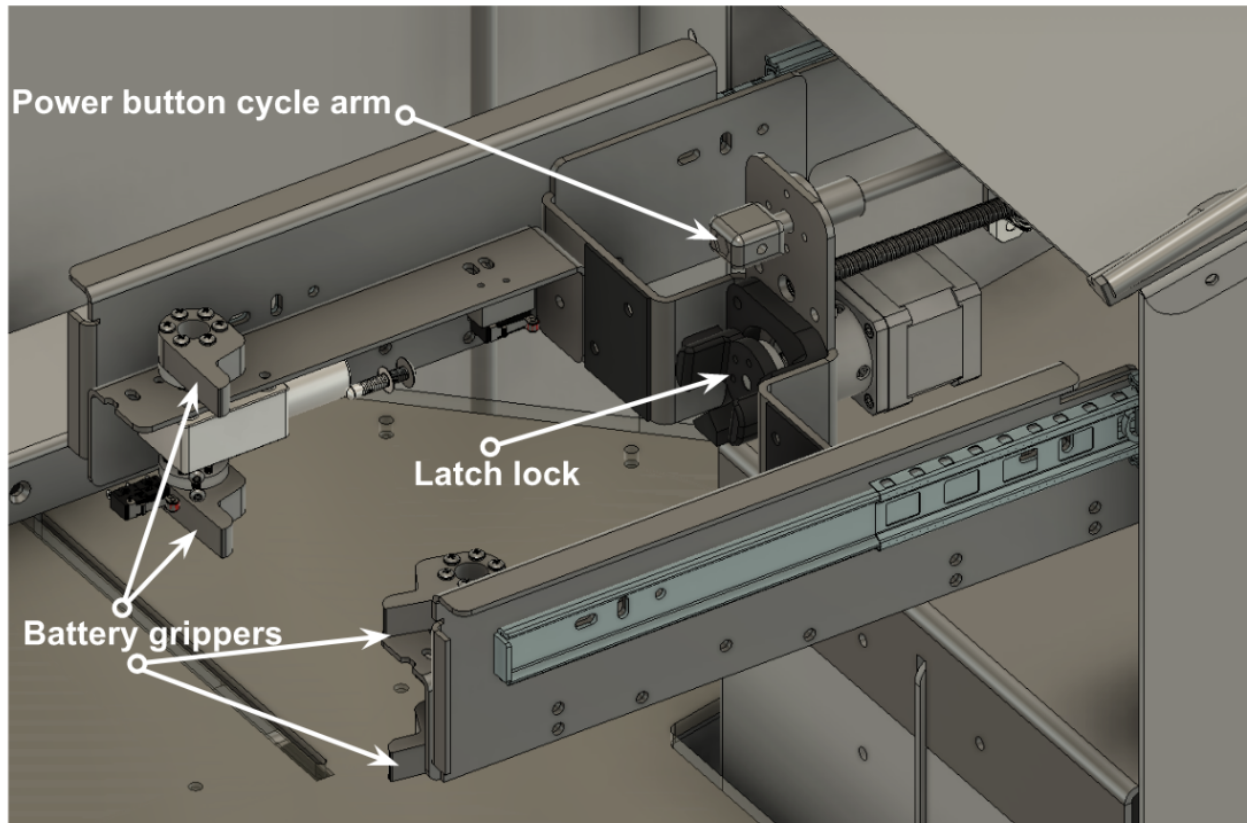

Power button cycle arm: This mechanical actuator physically presses the drone power button upon software input to toggle power on/off.

Latch lock: This mechanical actuator locks the battery in place by turning the latch upon software input.

Battery grippers: The gripping actuator used to grab batteries during removal/insertion.

H. Bulkhead Access panel

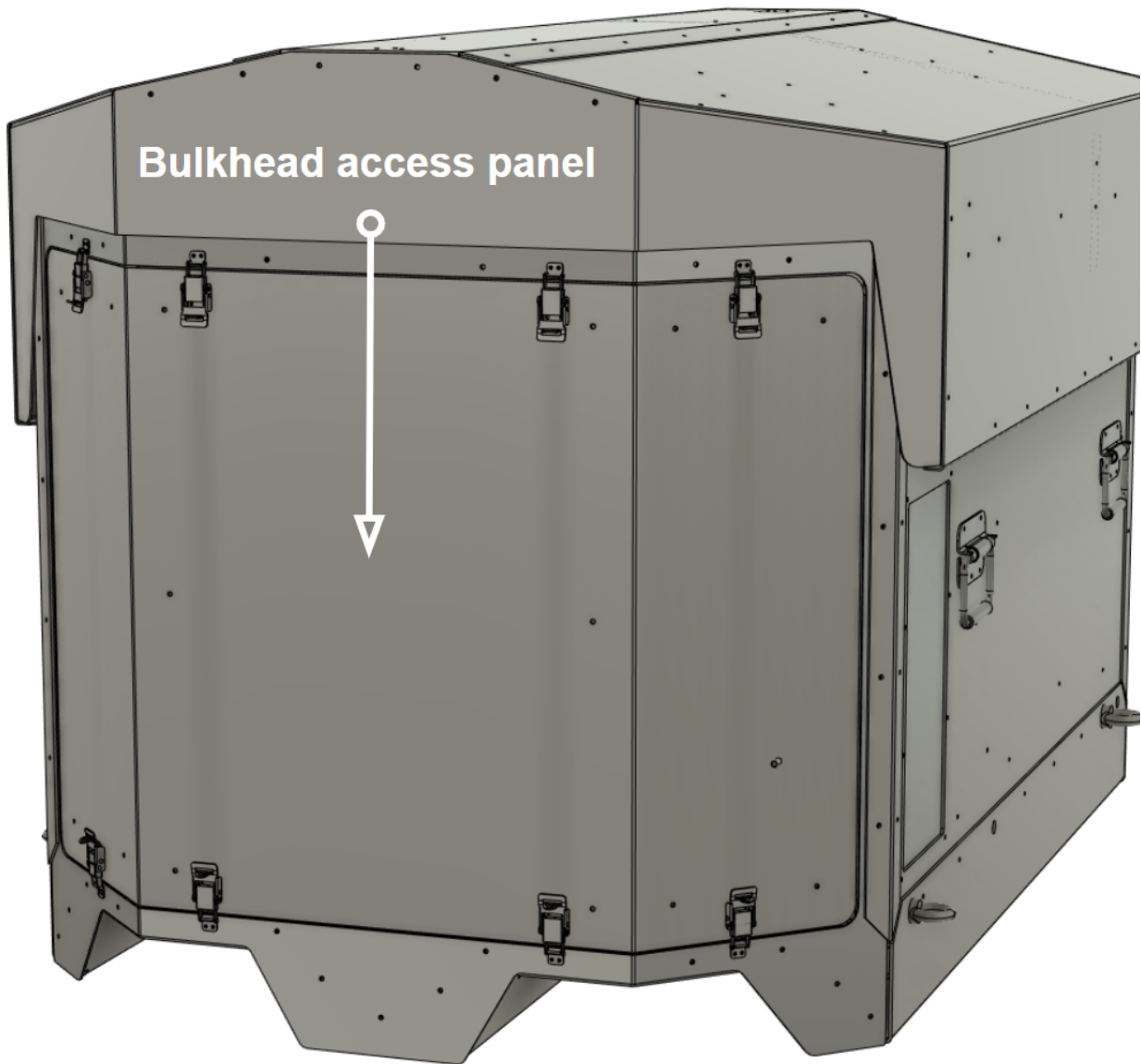

Bulkhead access panel: Removable panel used to access station internal components.

I. HVAC/ HVAC Controller

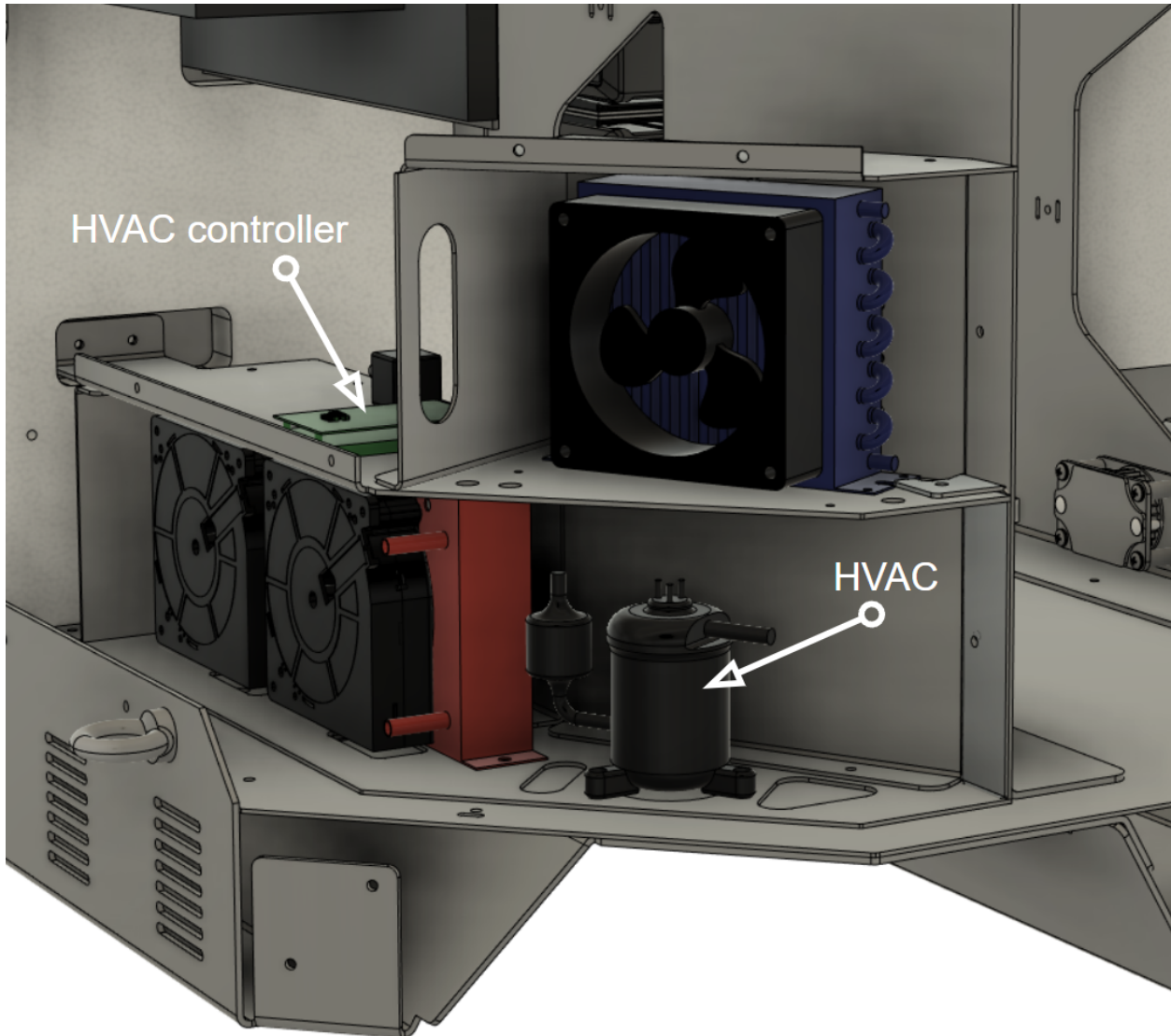

HVAC: A 200W compressor system capable of 500W cooling power and heating option for full climate control

HVAC Controller: climate control board, controls cooling and heating.

J. Battery Charger

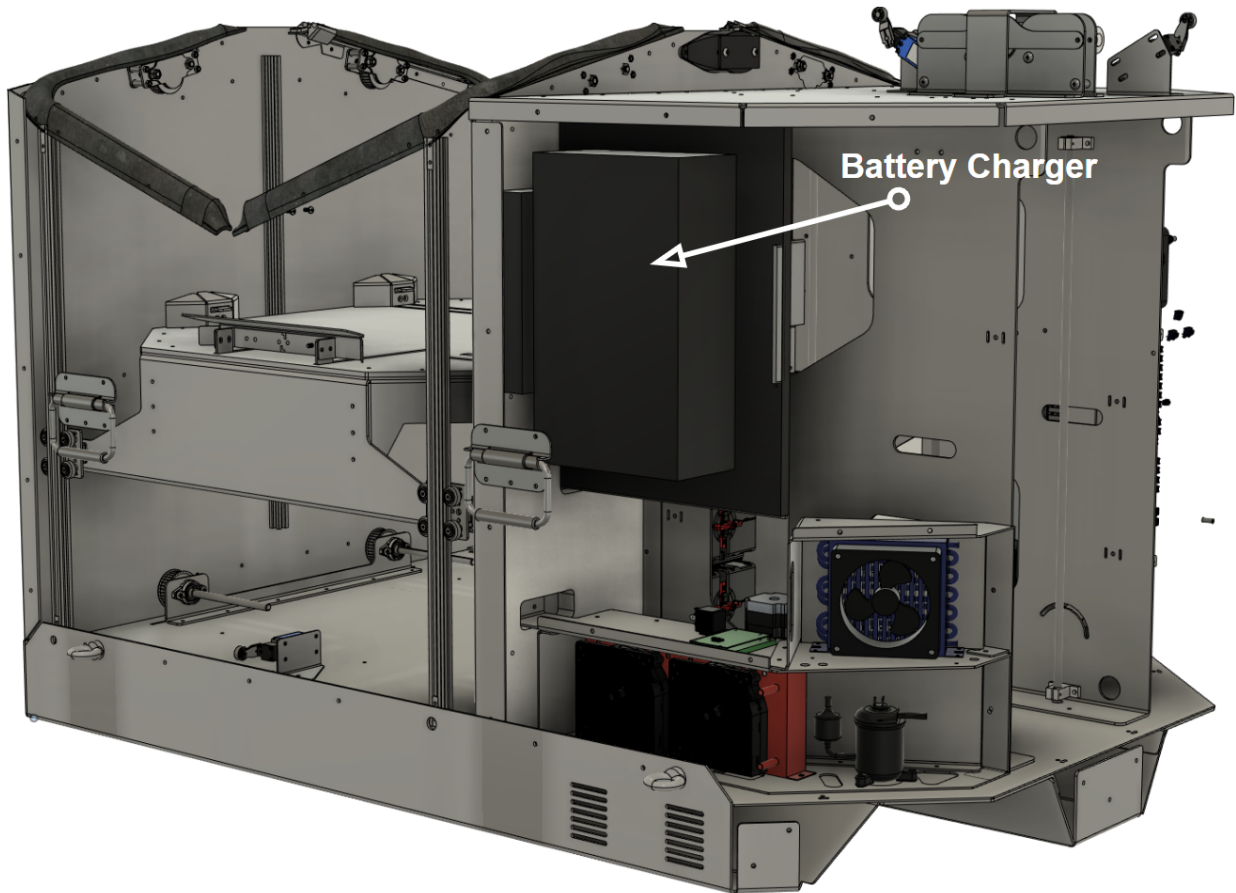

Battery charger: Charger connects to the Atlas battery Rack via a charging cable harness, charges and maintains 8 batteries.

K. Battery Rack

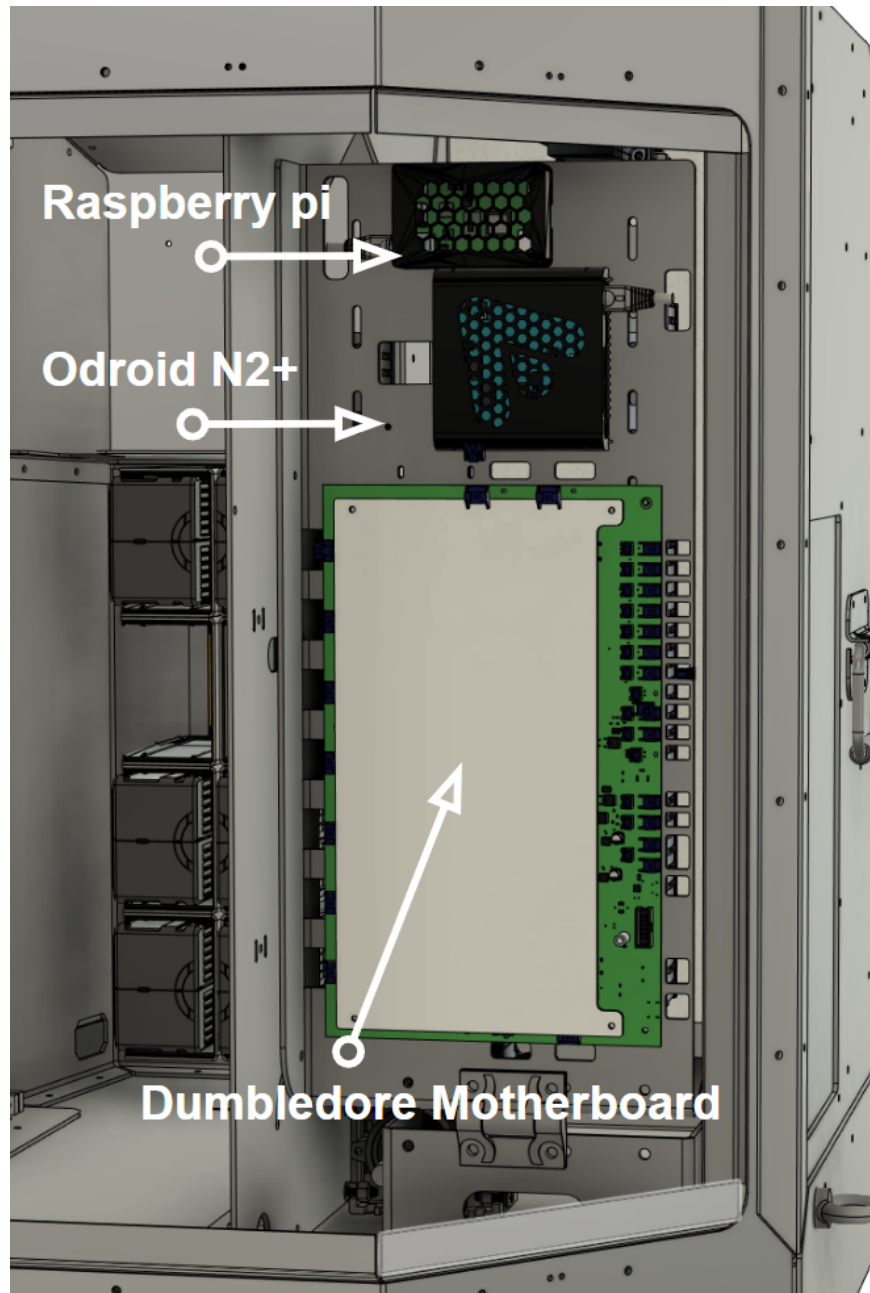

Battery rack: Contains eight battery slots used to house & charge M300 drone batteries.

L. Dumbledore Motherboard/ Raspberry Pi/ Odroid N2+

Dumbledore motherboard: 12V & 24V ESP32 microcontroller handles motor and switch actuation.

Raspberry Pi: Communicates and runs commands through Hextronics dashboard

Odroid N2+: Runs flight software and controls drone RC

M. IO Panel



I/O panel: The i/o panel consists of 4 connections and 1 keyed switch.

Main power outlet: IP67 Plug 110/240VAC for power.

USB communication port: USB port for external box connection.

Ethernet outlet: IP67 Plug for internet connectivity.

External box power outlet: IP67 Plug 110/240VAC for ext box power.

Roof key switch: Manual switch activates roof open/close

Technical Specifications

The Hextronics Atlas Drone Station has been specifically designed to work in conjunction with the DJI Matrice 300 drone for the purposes of battery swapping, charging, deployment and storage.

Properties:

- Dimensions: 55" x 43" x 39" or 1.4m x 1.1m x 1.0m
- Max Weight: 415lbs or 180kg
- Exterior Material: Insulated and Anodized Aluminum
- Radio Frequencies: 2.4 GHz - 5.0 GHz
- API Communication: Ethernet/4G LTE
- Input Power: 110VAC/240VAC, 50-60 Hz
- Max Power Consumption: 1500W

Hardware:

- Compatible Drones: DJI Matrice 300
- Battery Storage: 8 Sequentially Smart Charging at 110 min (0-100%) in pairs
- Cooling System: Compressor Based HVAC System
- Heating System: Thermoresistive 200W

Codes and Certifications:

- HS Code: 8543700000
- Weather Resistance: IP 55 (Pending)
- Certification: UL & CE (Pending)

Flight Software:

- Supported Provider: FlytNow Auto+
- Mission Planning: Scheduled and Continuous
- Video Recording/Uploading: 4K Quality, Cloud Storage
- Precision Landing Range: +/- 15cm
- Precision Landing Reliability: 99.99%

Performance:

- Max Operable Wind Speed: 20 knots
- Unobstructed Flight Radius: 7 km or 4.34 miles
- Operating Area: 15 sq km
- Max Flight Speed: 16 m/s

Sensors:

- Internal Temperature: 0.1°C Resolution
- Internal and External Cameras: 480p Streaming Resolution
- Wind Speed [Weather Station Add-On]: 1 mph Resolution
- External Temperature [Weather Station Add-On]: 0.1°C Resolution
- Humidity [Weather Station Add-On]: 1% Resolution
- Rain Gauge [Weather Station Add-On]: 1 mm/s Resolution
- Pressure [Weather Station Add-On]: 1 bar Resolution

Wiring Diagram

Contact support@hextronics.tech for a downloadable wiring diagram.

This wiring diagram includes detailed information about the electrical components and their connections within the system, providing a comprehensive overview of electrical architecture. By following the wiring diagram closely, you can ensure that your product is wired correctly, minimizing the risk of errors and ensuring safe and reliable operation.

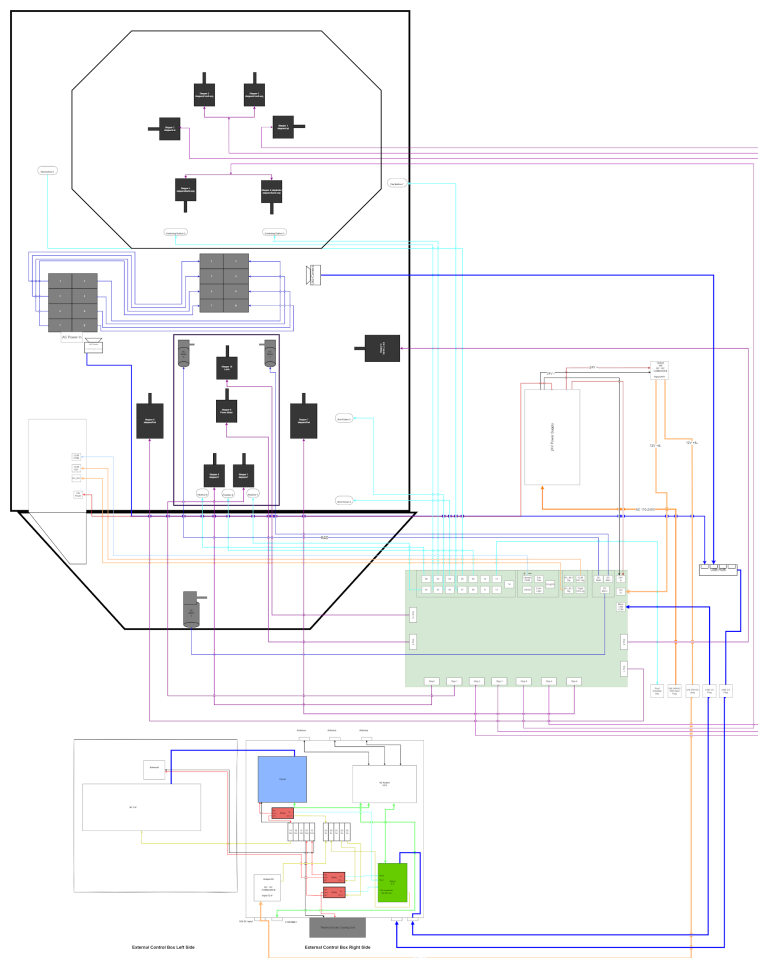

Installation

This section describes the installation process for the Atlas

Unboxing and Placement

Follow the instructions below in order. Once you have reached the end of this section, please proceed to the next section.

Unboxing

Inspect that the shipment is in good condition and that the pallet is intact for initial movement. Strapping the station is advised for every moving method.

Movement can be done with:

- A pallet jack (See image below for entry point)
- Multiple healthy able-bodied individuals via lifting handles (Short distances only)
- Mechanical lifting machinery via the lifting ports or via the pallet entry points

1. Open the wooden crate to free the Atlas station and remove the protective foam packaging.
2. Remove the externals box, externals pole and stand within the Atlas shipment.

Placement

Place the station on a flat-level surface.

Strapping the station is advised for every moving method.

Once you have placed the Atlas station at your desired location, please continue to the next steps for the initial setup of the station.

Initial Setup

Follow the instructions below in order.

1. Position the tripod base legs
 - a. Confirm that the chain is through each leg
 - b. Secure the carabiner lock
 - c. Spread the base legs for a balanced foundation



2. Secure the pole section to the base section



3. Insert Remote Controller & secure solenoid pusher to RC
 - a. Place the M300 RC into the external box
 - b. Insert the USB Type-C power cable into the C-type port on the bottom of the RC
 - c. Insert the USB Type-A Coms cable into the A-type port on the top of the RC
 - d. Attach RC power toggle assembly on top of the RC (Ensure the solenoid is directly over the power button)



4. Mount the external box to the bracket on the pole.
 - a. Insert two hose clamps through each of the two bracket openings
 - b. Elevate the external box to the preferred height
 - c. Secure the two clamps firmly to the base pole

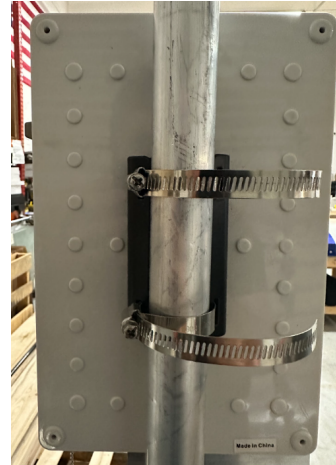

CAUTION The following steps should be done **in order**. It is important that the Ethernet cable is plugged in first to ensure Raspberry Pi internet connectivity is secured.

5. Insert assorted cables into the correct slots.

- Ethernet Cable _____ port 3
- USB Coms _____ port 2
- Externals Box _____ port 4
- Main Power _____ port 1
- Roof Key _____ port 5 ⚠
- USB Coms _____ Externals Box
- 4-pin Power _____ Externals Box

⚠ TURNING KEY WILL ACTIVATE ROOF



6. Remove the four rubber end caps from the drone feet
 - a. These pieces **must** be removed so that once the drone is on the landing pad it can slide freely during pad adjustment
 - b. Remove the rubber pieces and place the drone to the side on standby for the meantime



Battery Placement

1. Insert batteries into desired slots 1- 8.



2. Match the battery slot status to the physical batteries (1-8) within the station
 - a. Enter the **Hextronics Control Panel** and select **Advanced Menu** on the top right of the screen
 - b. Scroll down to locate the **Battery Slot Placement** tab
 - c. Set to **OCCUPY** if there is a battery in the slot
 - d. Set to **EMPTY** if the slot is empty
 - e. Select **SAVE CONFIGURATION** when you are ready

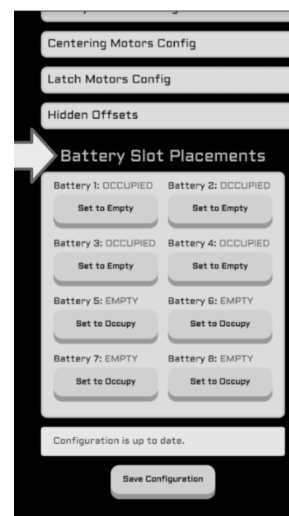

Hardware & Software Inspection

Please follow the steps below to inspect how the hardware & software operations work correctly. Please contact Support@hextronics.tech for assistance.

Login to the Hextronics Control Panel

Scan the QR code located within the black accessories folder and find the link within the Hextronics welcome email.



A screenshot of a black login form. At the top, it says "Log In" in white. Below that is the label "Password:" followed by a white rectangular input field. At the bottom of the form is a rounded rectangular button with the text "Log In" in white.

Password

The password will be everything within the parenthesis within the URL

(Hexone-xxxxxxxxxxxx).hextron.tech/**login of your unique URL.**

Once you've logged in you will be directed to the Atlas Commands page. You may select "Change Password" at the top of your screen if you prefer to do so.

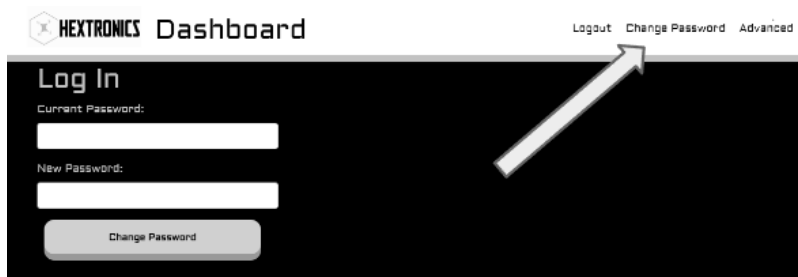

A screenshot of the Hextronics Dashboard. At the top left, it says "HEXTRONICS Dashboard" with a logo. At the top right, there are links for "Logout", "Change Password", and "Advanced". Below this is a "Log In" section with two input fields labeled "Current Password:" and "New Password:", and a "Change Password" button. A white arrow points from the "Change Password" button in the main content area to the "Change Password" link in the top navigation bar.

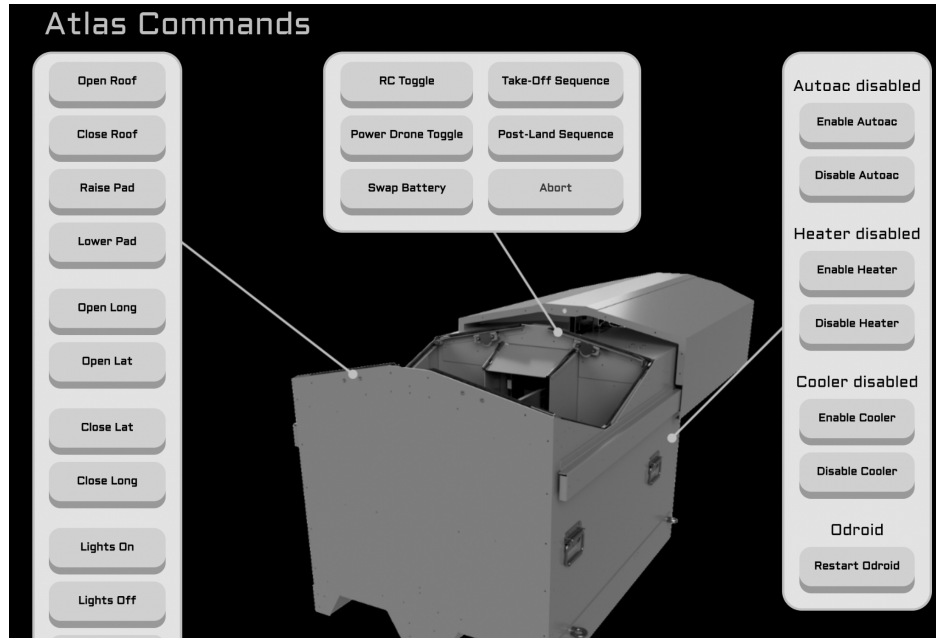

Atlas Commands Page²

Open Roof

Select **Open Roof** in the left panel of the Atlas Commands page.

Visually confirm that the roof of the drone station opens smoothly and fully.

Raise Pad

Select **Raise Pad** in the left panel of the Atlas Commands page.

Visually confirm that the pad of the drone station rises all the way.

Place Drone

Place the drone on the landing pad with the camera facing out.

² See [Navigating the Dashboard](#) section for details on all commands



Lat/Long

Select **Close Lat** in the left panel of the Atlas Commands page.

Select **Close Long** in the left panel of the Atlas Commands page.

Visually confirm that the adjusters move internally to the center of the drone.

Lower Pad

Select **Lower Pad** in the left panel of the Atlas Commands page.

Visually confirm that the pad lowers the drone into the station and the drone propellers safely retract toward the center of the drone.

Drone On/Off Mechanism

Select **Power Drone Toggle** in the middle panel of the Atlas Commands page.

Visually confirm that the *power ON/OFF* mechanism successfully presses the drone's power button and powers the *drone ON/OFF*

Battery Swap

Shut off the drone.

Select **Swap Battery** in the middle panel of the Atlas Commands page.

Visually confirm that battery removal and insertion is successful.

If all processes run successfully, **close the roof** and continue to the next section.

Operation limitations & Emergency Procedures

This section describes the limitations, emergency procedures, calibration, and operation of the Atlas

CAUTION Familiarize yourself with the flight & operation limitations, as well as the four emergency landing procedures prior to performing **any** drone station operations.

Flight Operation Limitations

- Connect your aircraft to the internet to update the database of DJI GEO Zones regularly. Consult the relevant local government agencies or governing bodies before flight to ensure you comply with all the relevant laws and regulations.
- Do not use the aircraft in severe weather conditions. These include wind speeds exceeding 15 m/s, snow, rain, and fog.
- When flying in open areas, tall and large metal structures may affect the accuracy of the onboard compass and GNSS system. Make sure to operate the aircraft by following the prompts in the app.
- Avoid obstacles, crowds, high voltage power lines, trees, and bodies of water.
- Minimize interference by avoiding areas with elevated levels of electromagnetism, including base stations and radio transmission towers.
- Aircraft and battery performance are subject to environmental factors such as air density and temperature. Be very careful when flying at high altitudes, as battery and aircraft performance may be affected.
- The compass and GNSS will not work in Polar Regions. Fly carefully.
- If flying in GEO Zones is required, apply for unlocking in advance. <https://www.dji.com/flysafe>
- Avoid operation of the Drone Station or performing missions during extreme weather conditions.

Drone Station Warnings

- Keep any liquids (oil, water etc.) away from the inside of the Drone Station.
- DO NOT block the ventilation ports located at the rear or underneath the drone station. Ensure the drone station has sufficient ventilation to regulate its internal temperature.
- The Atlas 300 Drone Station is only compatible with the TB60 Intelligent Flight Battery and the Matrice 300 Drone. DO NOT attempt to use the docking station with other models.
- Place the Drone Station on a flat and stable surface when in use. Ensure the device is properly insulated to prevent fire hazards.
- DO NOT touch the metal terminals on the battery charging racks, or the electrical connections within the station when the power is on. Wait 15 seconds after disconnecting power before touching.

-
- Take care to avoid injuring fingers or other bodily parts when operating the station. Ensure proper clearance behind the station before actuating the roof or activating any missions.
 - Only operate the Atlas Station under the guidelines of this user manual. If proper procedures are not followed, warranty of the docking station may be voided.
 - Air pressure in the Battery Station may change during air transportation or after extreme barometric pressure changes. The station should balance air pressure automatically.

Emergency Landing Procedures

1. Automatic control through Flight Software

Use this FlytNow sequence via the Utility window & Flight Controls to dock the drone without any battery swapping operations - This is used if the drone has been rained on during a mission, in order to dock the drone without inserting the WET drone battery into the station charging slots.

- a. Select ABORT current mission
- b. Select RTDS and select ABORT again when the drone is nearly above the docking station to cancel the sequence
- c. Manually fly the drone over the docking station & select Open Enclosure to open the pad Select Precision Land
- d. Select Close Enclosure once the drone has landed safely on the pad
- e. Note: This sequence will prompt the drone to land on the pad and be inserted into the station for housing but NOT proceed to remove the wet battery from the drone for battery swap operations.

2. Manual control through Flight Software

Three manual control options: 1. Keyboard 2. XBOX controller 3. On-screen³
Take manual control mid-flight in the drone FPV view by clicking the Joystick icon⁴

- a. Click the icons to change method of control (Keyboard / On-screen / External controller)
- b. Select Resume/abort mission to continue (Bottom right toolbar)
- c. Select Return to docking station to land the drone

³ See [How To Fly](#) Tab

⁴ Middle bottom of the FlytNow screen

3. Manually from the remote controller

If an operator is present near the drone station and it is determined that manual drone control must be taken the following steps must be done:

- The controller can be manually disconnected from the external control box and
- Switching the controller to “S” mode will allow the user to manually and instantly take over control of the aircraft in an emergency. (Diagram 1A)

Flight Mode Switch

Toggle the switch to select the flight mode. Choose between T-mode, P-mode, and S-mode.

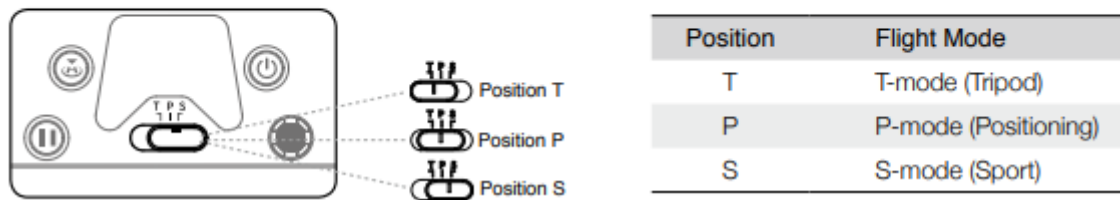

Diagram 1A

4. Loss of propeller automatic landing

During flight, if the aircraft lacks one lift output (e.g. propulsion system failure of a motor), it will automatically switch to the Three-propeller Emergency Landing Mode.

The flight controller will try to maintain the stability and controllability of attitude and velocity, and make the aircraft automatically land in this mode.

This mode enables a user to land the aircraft onto a safe zone by controlling the aircraft, helps to reduce the chance for the aircraft and payload to drop, and damage the people and property on the ground.

When the aircraft enters the Three-propeller Emergency Landing Mode, the remote controller will alert the user by vibrating.

At this time, the aircraft will enter rapid spin and automatically descend by default.

The stick that controls back and forth movement will be adjusted to control the north-south movement and the stick that controls the left and right movement will be adjusted to control the west-east movement.

The user can operate the sticks to move the aircraft to the appropriate landing area as soon as possible.

When the aircraft reaches near to the ground, the user can use the Emergency propeller stop to land the aircraft to minimize the drop loss caused by the aircraft spin.

Navigating the Dashboard

Hextronics Dashboard Main Menu

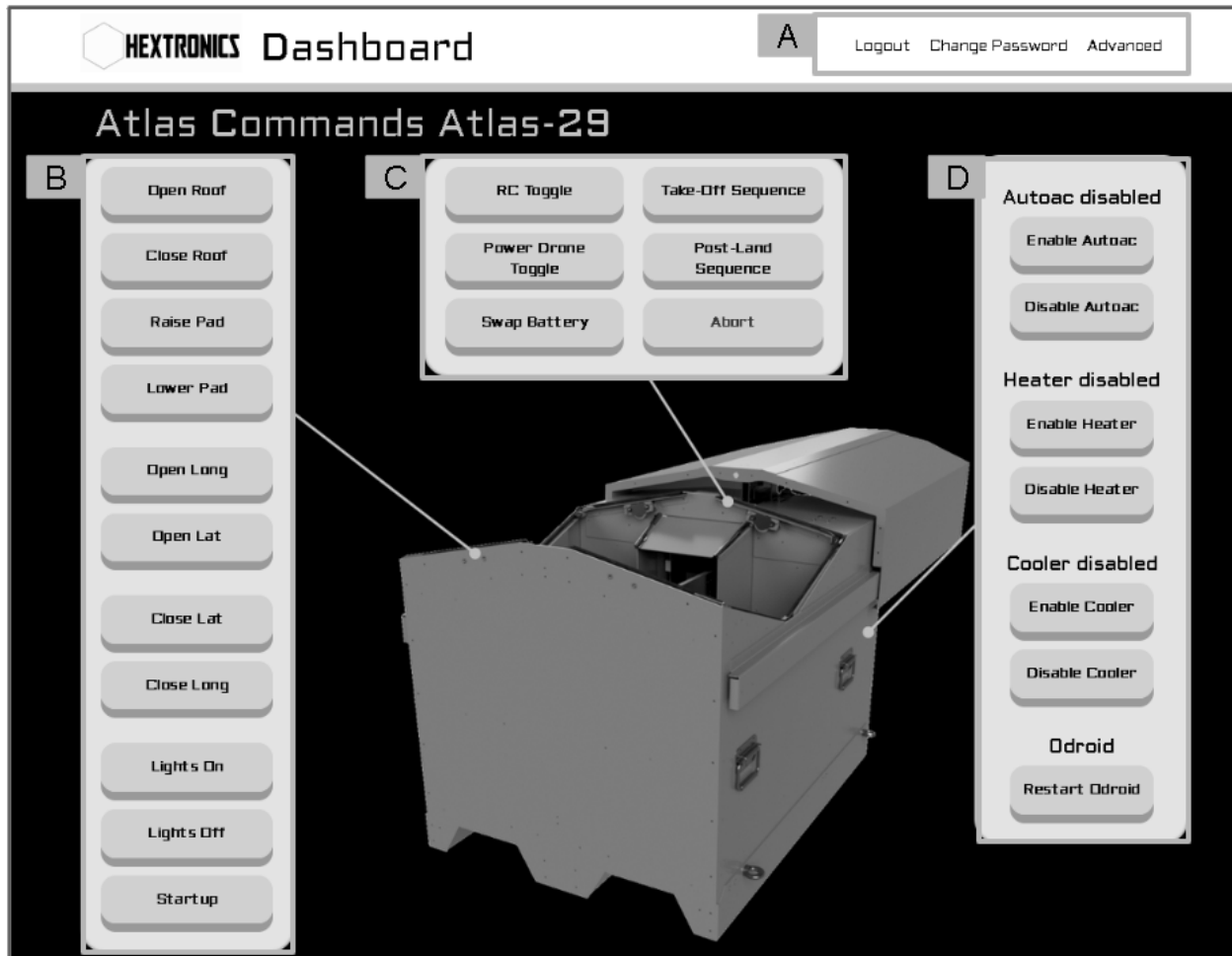

A. Account and Advanced Menu

Logout: Logs the user out of the dashboard.

Change Password: Changes the password of the users' ATLAS dashboard

Advanced: Access to the advanced menu for more options to test and tune the station

CAUTION The advanced menu should only be used by certified operators to avoid the risk of injury and damaging components

B. Basic Commands

Open Roof: Opens the roof of the station

Close Roof: Closes the roof of the station

Raise Pad: Automatically opens roof if not already opened, then raises the landing pad to its maximum height

Lower Pad: Lowers the pad all the way down to its zero position

Open Long: Opens the Longitude drone centering mechanism to its maximum open position

Open Lat: Opens the Latitude drone centering mechanism to its maximum open position

Close Lat: Closes the Latitude drone centering mechanism to its maximum close position

Close Long: Closes the Longitude drone centering mechanism to its maximum close position

Lights On: Turns on the interior and exterior LED lights of the station

Lights Off: Turns off the interior and exterior LED lights of the station

Startup: Enables the start-up routine which applies new configurations and settings the user may have changed, such as motor offsets.

C. Calibration Commands

RC Toggle: Activates the RC toggle linear actuating motor

Power Drone Toggle: Starts the drone power on/off routine

Swap Battery: Starts the battery swapping routine

Take-Off Sequence: Completely opens up the station so the drone is ready to take off

Post-Land Sequence: Completely closes up the station once the drone lands

Abort: stops all current operations

D. Cooler/Heater and Odroid options

Enable Auto AC: Enables the Auto AC option in which the HVAC system automatically turns on based on the users' inputted temperature threshold

Disable Auto AC: Disables the automatic AC option.

Enable Heater: Turns on the HVAC thermo-electric heater

Disable Heater: Turns off the HVAC thermo-electric heater

Enable Cooler: Turns on the HVAC cooler

Disable Cooler: Turns off the HVAC cooler

Restart Odroid: Restarts the Odroid N2+ Flight Software computer

Recent Commands and Telemetry

The screenshot displays three panels from the Atlas user interface:

- Panel A: Recent Commands**
 - Header: Recent Commands
 - Text: Clearing the queue will cancel all queued commands. If a command is currently in progress, HexONE will continue executing it.
 - Table of commands and completion times:

| Command | Done Time |
|--------------|---------------------------|
| lights on | done: 05/16, 13:39:08 EDT |
| close lat | done: 05/16, 13:39:29 EDT |
| close long | done: 05/16, 13:39:47 EDT |
| swap battery | done: 05/16, 13:45:30 EDT |
| swap battery | done: 05/16, 13:49:47 EDT |
 - Buttons: Refresh, Clear the Queue
- Panel B: System Information**
 - Header: System Information
 - List of system status items:
 - Station Type: Atlas
 - System: Resting
 - Roof Status: Open
 - Pad Occupancy: Occupied
 - Pad Level: Lowered
 - Pad Buttons Status: Left
 - Lat: Closed
 - Front Long: Closed
 - Back Long: Closed
 - Climate Mode: Manual
 - Temp: 82 °F / 28 °C
 - Swaps Performed: 7
 - Location: 26.6113, -80.1743
 - Network:
 - Current Version: 2.8.0
 - Uptime Since Reboot: 0W:4D:21H:56M
 - Telemetry Time: 5/16/2023, 1:53:48 PM
 - Download HexONE Logs
- Panel C: Temperature History**
 - Header: Temperature History
 - Text: Move your cursor over the lines to view more information.
 - Button: Switch to °C
 - Line graph showing temperature history over time. The y-axis is labeled Temp(°F) and ranges from 79°F to 83°F. The x-axis is labeled Time and shows 13:51:48 GMT-0400 (Eastern Daylight Time).

A. Recent commands

Refresh: Refreshes the command log to display the latest information

Clear The Queue: Clears the commands currently in queue

B. System Information

Download HexONE Logs: Downloads the weekly operation logs of the station

C. Temperature History

Switch to: Switches temperature scale

Battery Information

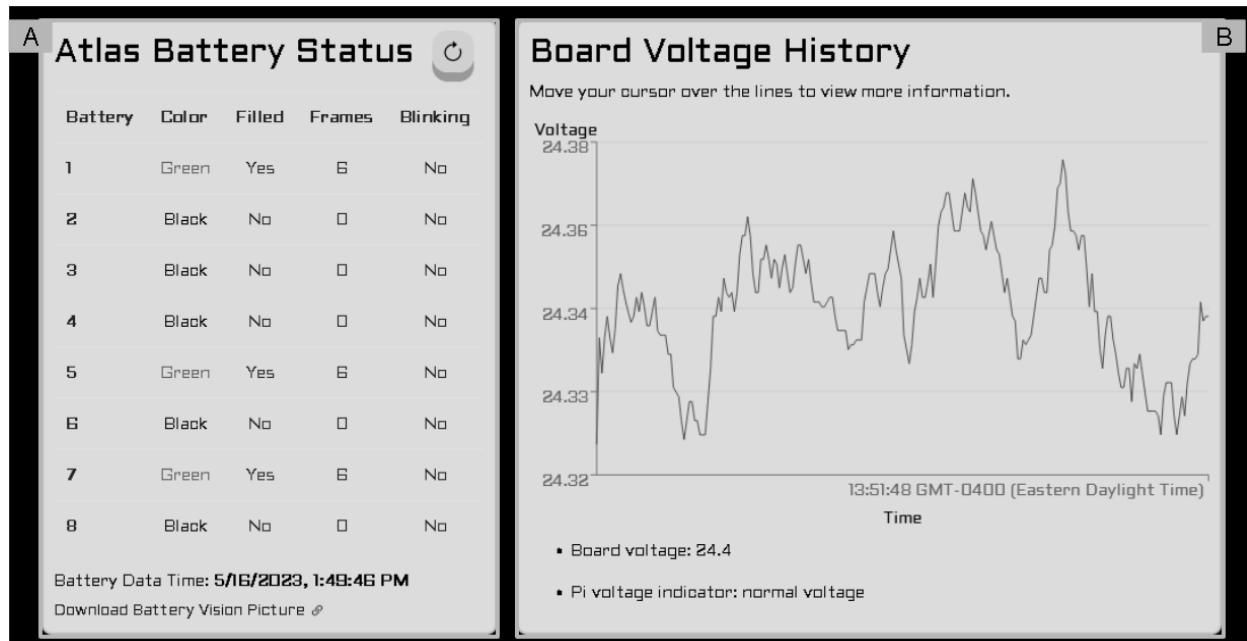

A. Atlas Battery Status

This sub-menu displays the battery charging status of slots 1 through 8.

↻: Refreshes battery status for the latest data

Download Battery Vision Picture: Takes and downloads an image of the Charging Docks battery status

B. Board Voltage History

This sub-menu displays the voltage history on a line graph. The user can move their cursor along the graph for an accurate timestamp.

Stepper Motor Information

| Atlas Stepper Motors | | | | | | | | | | | |
|----------------------|------------------|-----------|-----------------|------------|-------------|------------|-----------|---------|-------------------|-------------------|----------------------|
| Motor Stepper Unit | Current Position | Zero Fail | Time of Last Op | Hit Switch | Last Switch | Zero Error | Zero Time | Stalled | Base Stall Thresh | Last Stall Thresh | Last Travel Distance |
| Step0 | 0 | false | 18321 | true | 0 | 7 | 18323 | false | 12 | 12 | 300 |
| Step1 | 0 | false | 18328 | true | 1 | 18 | 18330 | true | 12 | 12 | 300 |
| Step2 | 18983 | false | 16379 | false | 0 | 0 | 0 | true | 2 | 2 | 31500 |
| Step3 | 30881 | false | 16384 | false | 0 | 0 | 0 | true | 2 | 2 | 31500 |
| Step4 | 3642 | false | 2377 | false | 0 | 0 | 0 | true | 8 | 8 | 2800 |
| Step5 | 18931 | false | 8985 | false | 0 | 0 | 0 | true | 8 | 8 | 19000 |
| Step6 | 2080 | false | 2172 | true | 6 | 119 | 1579 | false | 0 | 6 | 2080 |
| Step7 | 2080 | false | 2174 | true | 7 | 97 | 1590 | false | 0 | 6 | 2080 |
| Step8 | -2380 | false | 544 | true | 8 | -8 | 5312 | false | 10 | 6 | 180 |
| Step9 | 0 | false | 0 | false | 0 | 0 | 0 | false | 10 | 6 | 0 |
| Step10 | -10739 | false | 5297 | true | 20 | 137 | 4439 | false | -2 | -2 | -8039 |

| Motor Stepper Unit | Home on Switch | Idle Lock | Speed | Zero Speed | Accel | Microsteps | RMS | Zero Direction | Drive Direction | 5G Unlock |
|--------------------|----------------|-----------|-------|------------|-------|------------|------|----------------|-----------------|-----------|
| Step0 | true | false | 1600 | 0 | 1600 | 2 | 1700 | 1 | 1 | true |
| Step1 | true | false | 1600 | 0 | 1600 | 2 | 1700 | 1 | 1 | true |
| Step2 | true | false | 2100 | 0 | 2100 | 2 | 1300 | -1 | 1 | true |
| Step3 | true | false | 2100 | 0 | 2100 | 2 | 1300 | -1 | 1 | true |
| Step4 | true | false | 2600 | 0 | 2000 | 4 | 1600 | -1 | 1 | true |
| Step5 | true | false | 2600 | 0 | 2000 | 4 | 1600 | -1 | 1 | true |
| Step6 | false | false | 1800 | 0 | 1800 | 4 | 1700 | -1 | 1 | true |
| Step7 | false | false | 1800 | 0 | 1800 | 4 | 1700 | -1 | 1 | true |
| Step8 | false | false | 2000 | 0 | 2000 | 4 | 1700 | 1 | 1 | true |
| Step9 | true | false | 2000 | 0 | 3000 | 4 | 1000 | 1 | 1 | true |
| Step10 | true | false | 1750 | 0 | 3520 | 4 | 1200 | 1 | 1 | true |

A. Stepper Motor Information

Toggle Desc: Toggles the description of each motor

Advanced Settings Main Menu

HEXTRONICS Dashboard Logout Change Password Advanced

A **Navigation**
 Atlas-29
 Stepper Motors
 Commands Menu
 Offsets Menu
 Batteries Menu
 Demo Menu
 Cooling Menu
 Atlas User Manual [↗](#)
 Atlas Swap Logic [↗](#)
 Atlas Wiring Diagram [↗](#)

B **Advanced Settings**
 Atlas Stepper Motors (click to show) Toggle Desc

C **Testing Commands**
 Main Manual 1 Manual 2 Calibration
 Power Drone Toggle RC Toggle
 Swap Battery Batt Vision Update
 Open Roof Close Roof
 Raise Pad Lower Pad
 Open Lat Close Lat
 Open Long Close Long
 Lights On Lights Off
 Full Report Telemetry Update
 Start Up

D **Recent Commands**
 lightson done: 05/16, 13:39:09 EDT
 closelat done: 05/16, 13:39:29 EDT
 closelong done: 05/16, 13:39:47 EDT
 swapbattery done: 05/16, 13:45:30 EDT
 swapbattery done: 05/16, 13:49:47 EDT
 Refresh Abort

System Information
 • Station Type: Atlas • System: Resting
 • Roof Status: Open • Swap Cycles: 7
 • Pad Level: Lowered • Climate Mode: Manual
 • Pad Occupancy: Occupied • Cooler State: Disabled
 • Pad Buttons Status: Left • Heater State: Disabled
 • Lat Status: Closed • Temp: 83 °F / 28 °C
 • Front Long Status: Closed • API Version: 2.0.0
 • Back Long Status: Closed • Firmware Version: 2.4.2
 Uptime: 0W:4D:22H:0M
 Telemetry Time: 5/16/2023, 1:57:48 PM
 Download HexONE Logs [↗](#)
 1GN | 2BN | 3BN | 4BN | 5GN | 6BN | 7GN | 8BN |
 Battery Data Time: 5/16/2023, 1:49:46 PM
 Download Battery Vision Picture [↗](#)
 • Last Deposited Row: 1 • Next Empty Row: 2
 • Last Retrieved Row: 2 • Next Occupied Row: 1

A. Navigation Tab

This sub-menu includes quick access to information in the advanced menu.

CAUTION The advanced menu should only be used by certified operators to avoid the risk of injury and damaging components

B. Atlas Stepper Motors

This sub-menu grants quick access to Stepper Motor Information

C. Testing Commands

This Sub-menu includes 4 Tabs with different Testing and Calibration Commands

D. Recent Commands and System Information

Offsets Main Menu

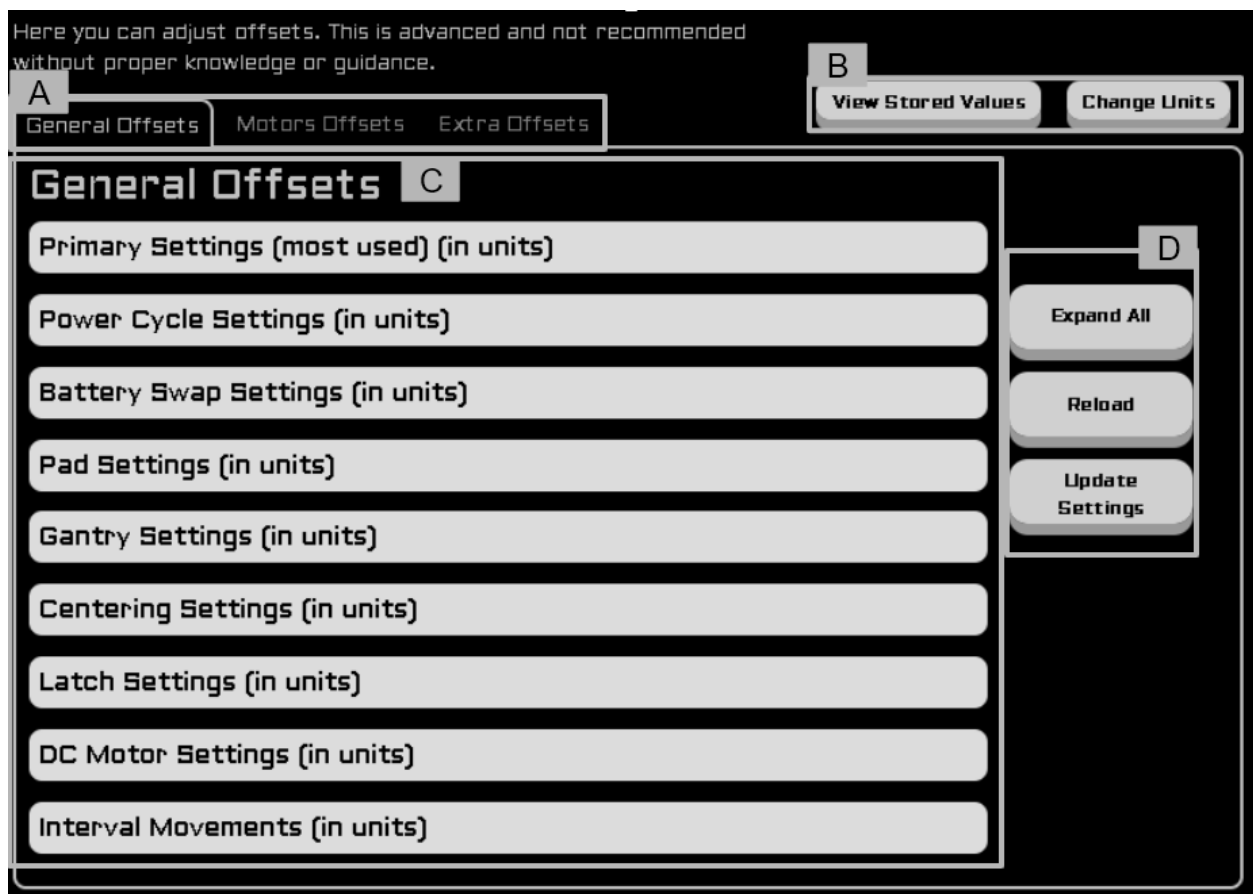

CAUTION The advanced menu should only be used by certified operators to avoid the risk of injury and damaging components

A. Offset tabs

These tabs allow the user to cycle through different offset settings.

General Offsets: Primary offset settings used when calibrating the station

Motor Offsets: Offset settings for all motors in the station

Extra Offsets: Extra offset settings for possible use in future updates (These offsets are currently not in use)

B. Stored values and change units

View Stored Values: Provides a summary of all currently stored settings and offset values

Change Units: Changes the unit measurement of the offset settings. (Unit conversion may vary between different motors)

C. Offsets menu

Access individual offset settings to tune the ATLAS

D. Offset menu control

Expand All: Expands and displays all offset tabs and values

Reload: Refreshes offsets menu to display current changes

Update Settings: The user must click this button to apply any changes made to offset values.

Battery Slot and Row Settings



A. Battery slot placements

This sub-menu displays the current occupancy state and allows the user to set the occupancy state of each battery slot.

Save Configuration: Saves changes made to battery occupancy states

Reload: Refreshes Battery Slot Placement menu to display current changes the user has made

B. Battery Row Status

This sub-menu displays the current state of each battery row and allows the user to enable or disable battery rows.

Save Configuration: Saves changes made to battery row status

Reload: Refreshes Battery Row Status menu to display current changes the user has made

Demo Mode Settings and Cooling Menu

The image shows two screenshots of a user interface. The top screenshot, labeled 'A', is titled 'Demo Mode Settings'. It displays 'Currently Demo Mode is: DISABLED' and a checkbox for 'Enable Demo Mode'. Below this is a section for 'Selected Steps' with checkboxes for 'pad (lower, raise)', 'roof (open, close)', 'lat (open, close)', 'long (open, close)', 'dronepower (toggle)', and 'swapbattery' (which is checked). An 'Update Demo Mode' button is at the bottom. The bottom screenshot, labeled 'B', is titled 'Cooling Menu'. It is split into two panels. The left panel is 'Compressor', with instructions to edit PWM to reduce noise or increase performance, a default of 7000, and an 'Update PWM' input field. The right panel is 'Temperature Threshold', with instructions to set a range for the cooling system, and input fields for 'Update Upper Threshold (°C)' and 'Update Lower Threshold (°C)'. Both panels have a 'Save' button at the bottom.

A. Demo mode settings

This sub-menu allows the unit to enable/disable a custom demo mode.

Update Demo Mode: Updates and applies changes made to the demo settings

B. Cooling Menu

In this menu, the user can set the PWM Compressor value as they see fit in order to reduce noise or increase performance. The user can also set an upper and lower temperature threshold range to better suit the region's climate.

Save: Saves the users' custom PWM compressor value and Temperature Threshold values

Testing Commands Expanded

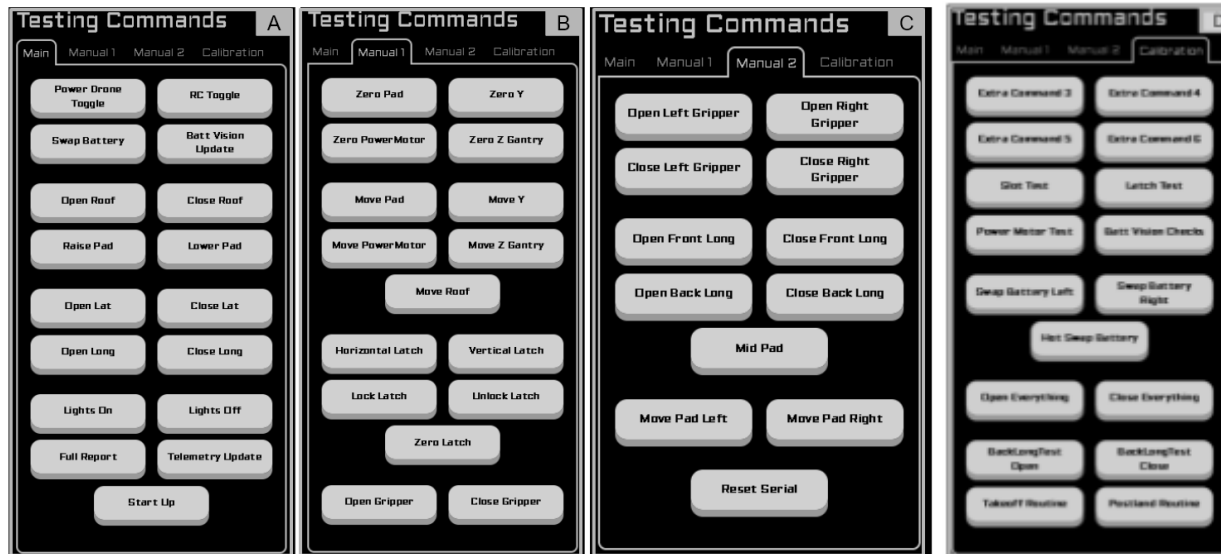

CAUTION The advanced menu should only be used by certified operators to avoid the risk of injury and damaging components

A. Testing commands Main

Power Drone Toggle: Starts the drone power on/off routine

RC Toggle: Activates the RC toggle linear actuating motor

Swap Battery: Starts the battery swapping routine

Batt Vision Update: Takes an image of the charging docks charging indicator and updates the download link for Battery Vision

Open Roof: Opens the roof of the station

Close Roof: Closes the roof of the station

Raise Pad: Automatically opens roof if not already opened, then raises the landing pad to its maximum height

Lower Pad: Lowers the pad all the way down to its zero position

Open Lat: Opens the Latitude drone centering mechanism to its maximum open position

Close Lat: Closes the Latitude drone centering mechanism to its maximum close position

Open Long: Opens the Longitude drone centering mechanism to its maximum open position

Close Long: Closes the Longitude drone centering mechanism to its maximum close position

Lights On: Turns on the interior and exterior LED lights of the station

Lights Off: Turns off the interior and exterior LED lights of the station

Full Report: Updates motor and firmware information⁵

Telemetry Update: Forces telemetry update (Telemetry updates automatically every 6 seconds)

Start Up: Enables the start-up routine which applies new configurations and settings the user may have changed, such as motor offsets.

B. Testing commands **Manual 1**

Zero Pad: Lowers landing pad to full zero position

Zero Y: Moves Y-axis gantry to full zero position

Zero Power Motor: Moves power button motor to full zero position

Zero Z Gantry: Moves Z-axis gantry to full zero position

Move Pad: Moves landing pad based on the users applied "move pad" interval movement value

Move Y: Moves Y-axis gantry based on the users applied "move Y" interval movement value

Move Power Motor: Moves Drone Power Motor based on the users applied "Move Power Motor" interval movement value

Move Z Gantry: Moves Z-axis gantry based on the users applied "move Z gantry" interval movement value

Move Roof: Moves Roof based on the users applied "Move Roof" interval movement value

Horizontal Latch: Rotates Latch motor to horizontal position

Vertical Latch: Rotates Latch motor to vertical position

Lock Latch: Rotates Latch to lock position

Unlock Latch: Rotates Latch to unlocked position

Zero Latch: Roatates Latch motor to full zero position

Open Gripper: Moves gripper DC motors to "open" position

Close Gripper: Moves gripper DC motors to "close" position

C. Testing Commands **Manual 2**

Open Left Gripper: Moves Left gripper DC motor to "open" position

Open Right Gripper: Moves Right gripper DC motor to "open" position

Close Left Gripper: Moves Left gripper DC motor to "close" position

Close Right Gripper: Moves Right gripper DC motor to "close" position

Open Front Long: Opens the front side Longitude drone centering mechanism to its maximum open position

Close Front Long: Closes the frontside Longitude drone centering mechanism to its maximum open position

Open Back Long: Opens the backside Longitude drone centering mechanism to its maximum open position

⁵ Shown in Stepper Motor Information above

Close Back Long: Closes the backside Longitude drone centering mechanism to its maximum open position

Mid Pad: This is a command that is still in BETA to be provided in future updates

Move Pad Left: Moves Left pad motor based on the users applied interval movement value for alignment purposes

Move Pad Right: Moves Right pad motor based on the users applied interval movement value for alignment purposes

Reset Serial: Resets serial connection to the dumbledore control board

D. Testing Commands **Calibration**

These are testing commands to be used when calibrating the station.

Extra Command 3: Moves landing pad and gantry to battery swap position with grippers opened

Extra Command 4: Closes grippers to grab batteries, unlocks latch and retracts batteries.

Extra Command 5: Gantry moves to zero position, pad goes to zero then back to swap position, gantry moves into swap position and rotates latch to horizontal position.

Extra Command 6: Gantry inserts batteries into drone, opens grippers, locks latch, then gantry Y-axis returns to zero.

Slot Test: Gantry grabs drone batteries and inserts them into each charging slot.

Latch Test: Moves gantry to swap position, unlocks then locks battery latch.

Power Motor Test: Moves the power motor to its extended position and returns to zero

Batt Vision Checks: Takes an image of the charging docks charging indicator and updates the download link for Battery Vision

Swap Battery Left: Swap routine for the "left" drone battery

Swap Battery Right: Swap routine for the "right" drone battery

Hot Swap Battery: Swaps left and right battery one at a time

Open Everything: if Drone is detected, it raises pads while opening the centering mechanism. If Drone is not detected, then the pad rises.

Close Everything: Lats and longs are closed to check if the drone is on the pad. IF the drone is detected, open lat/longs while lowering the pad. If the drone is not detected, then the pad lowers.

Back Long Test Open: Opens backside long centering mechanism

Back Long Test Close: Closes backside long centering mechanism

Takeoff Routine: Gantry Y-axis goes to zero, pad goes to zero, roof opens, pad rises and opens centering mechanisms.

Post Land Routine: Centering mechanisms close, pad lowers to zero position, roof closes, then drone gets powered off.

Station Calibration: Instructions

Calibration must only be done by a certified operator/ technician to eliminate the risk of injury or damaging components.

CAUTION Be careful when adjusting these values. Adjust in small increments to avoid damaging components.

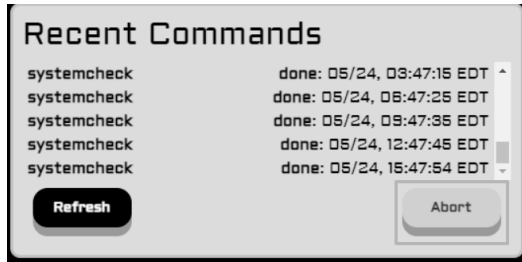

The **Abort** command will stop all current operations, be ready to press this button in the event of failure to prevent damaging components. This command can be found in the **Recent Commands** sub-menu on the Dashboard.

Default Value

BodyDistAmount (-500): ⓘ

-220

Current Offset

Final Value = Default - Current Offset
 Final Value = - 500 - (-220) = -280
 This will DECREASE bodyDistAmount

Key (Legend)

Offset values entered are represented as follows:
 O_{1,2,3...} are global variables to the sheet
 X_{1,2,3...} are local variables to the text box

Gantry Z-Axis offset

Gantry Y-Axis offset

Pad Z-Axis offset

Power Motor Y-offset

Pressing a Command

Offset values should be entered as an amount relative to the default # of steps value shown in (parenthesis)

The Key (Legend) will clarify the flow charts used in these instructions.

Centering Mechanism

Centering Settings (in units)

| | |
|---|--|
| LatDistAmount (15750u): (i) | LongDistAmount (5200u): (i) |
| <input type="text"/> | <input type="text"/> |
| FrontLongDistAmount (4750u): (i) | BackLongDistAmount (3050u): (i) |
| <input type="text"/> | <input type="text"/> |

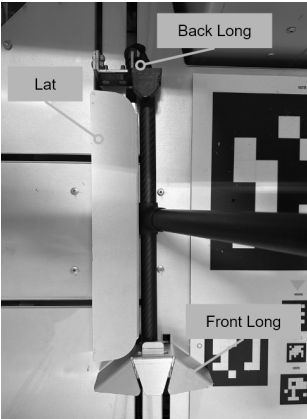

CAUTION This is likely correctly calibrated out of the box and should only be changed if major discrepancies are observed

Note:

Centering Settings can be found in the Primary settings tab on the General Offsets menu, located on the Advanced page.

Centering Mechanism commands can be found in the Testing Commands sub-menu located on the Advanced page.

A higher negative value increases the distance these mechanisms move.

LatDistAmount: should be adjusted to the point at which the drone's legs are being touched, but not to the point of overcompression. The drone should still be able to slide back and forth when the lats are closed.

FrontLongDistAmount: Should be used to close the "front long" centering mechanism to the point shown

Gantry Z-axis

Calibrate the height of the gantry Z-axis due to variations in gantryZ zero height.

1. Power on the Atlas, then remove all batteries in the charging rack and remove the drone from the station

- Removing the Bulkhead (Rear access panel) will grant access to the battery charging rack.
- If a drone is inside the station, use **open roof** and **open lat/long** to remove the drone.

2. Press **SlotTest**⁶ and observe the gantry moving to each slot in the battery charging rack. The gripper fingers on the gantry need to be approximately centered in each battery row on the charging rack. If the gantry is too high or too low, respectively increase or decrease the value of **GantryZeroAmount**.

- Use the **Abort** command if you sense the gantry will collide against the charging rack or other components.
- Continue repeating this step until the gantry gripper fingers are properly centered on each battery row.
- The **SlotTest** function moves the gantry into each battery row and then returns the gantry to zero position.
- The **GantryZeroAmount** value affects the distance the gantry moves after the Zero limit switch has been activated.

3. Insert the drone into the station and close the **Lat/Long** centering mechanism.

- The drone must be equipped with both batteries.
- Make sure the lats/longs have only been activated once.

⁶ Located in the Advanced Menu

Pad-Z and Gantry-Y

Calibrate the distance the gantry extends, and the height at which the drone is relative to the gantry for swapping

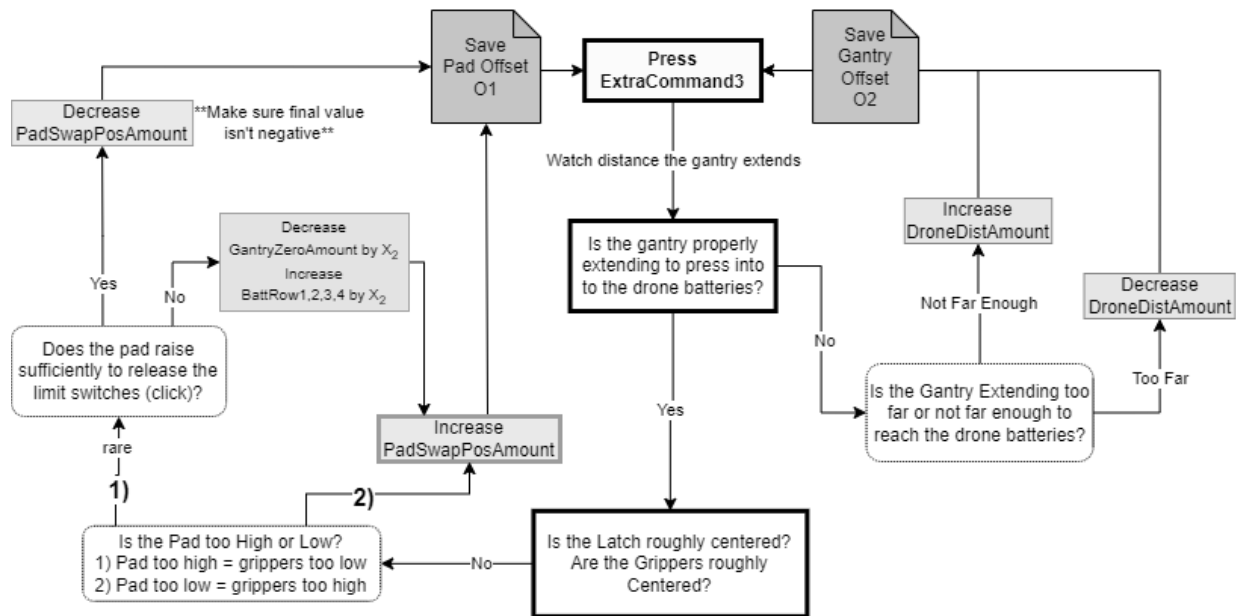

Pad-Z and Gantry-Y Calibration Flow Chart

1. Run **ExtraCommand3** and observe the distance the gantry extends. The gantry should extend far enough to reach and firmly press the drone batteries. If the distance is too short or too far, respectively increase or decrease the **DroneDistAmount**⁷.

- Motorized latch mechanism should be in contact with the drones battery latch
- gantry battery pads should be in contact with the drone batteries
- Use the **Abort** command if the gantry presses the drone too much or collides with other components.
- Repeat this step until the gantry reaches the appropriate distance to the drone.
- Once the appropriate distance has been reached, Save the **Gantry Offset** value.
- The **ExtraCommand3** button is located on the testing commands sub-menu in the calibration tab.

⁷ Can be located in the Primary Settings Menu

2. Observe whether or not the gantry motorized latch mechanism and battery grippers are vertically centered on the drone's battery latch and batteries. If the gantry is vertically centered with the drone's latch and batteries, move on to Battery Rack-Z calibration. If not, continue to step 3.

- Images depict vertically aligned gantry grippers and gantry latch mechanism.

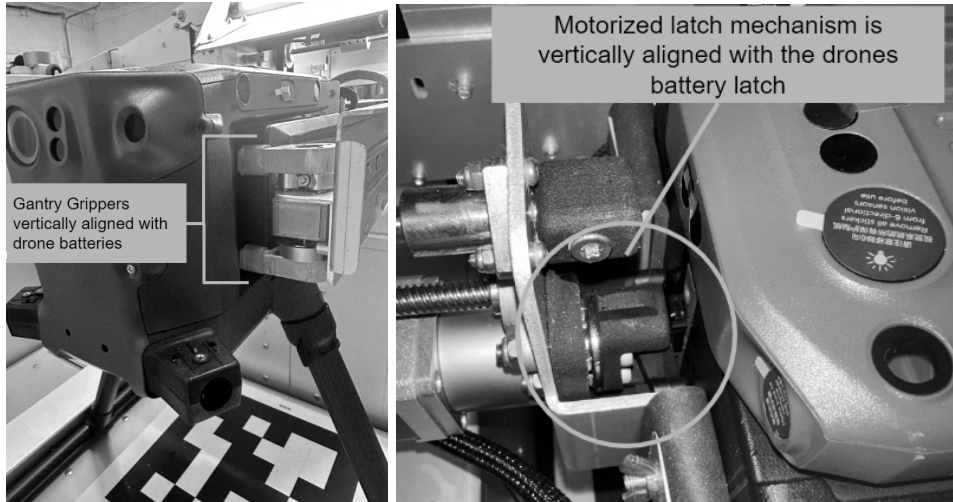

3. To vertically align the gantry grippers and gantry latch mechanism, the height of the landing pad must be adjusted.

- If the landing pad is too high/grippers are too low
 - Observe if the pad rises sufficiently enough to release the pad limit switches
 - If the pad does raise enough to release the limit switches, decrease **PadSwapPosAmount** until the gantry grippers and Latch mechanism are vertically aligned with the drone batteries and latch. Save **Pad Offset**.
 - If the pad does not raise enough to release the pad limit switches, decrease **GantryZeroAmount** by X2 and increase **BattRow1,2,3,4** by X2. Then increase **PadSwapPosAmount** until the gantry grippers and Latch mechanism are vertically aligned with the drone batteries and latch. Save **Pad Offset**.
 - Run **ExtraCommand3** to verify vertical alignment.
- If the landing pad is too low/grippers are too high
 - Increase **PadSwapPosAmount** until the Gantry grippers and Latch mechanism are vertically aligned with the drone's batteries and latch. Save **Pad Offset**.
 - Run **ExtraCommand3** to verify vertical alignment.

Battery Rack-Z

Ensure proper alignment of the batteries when inserting them into the battery rack.

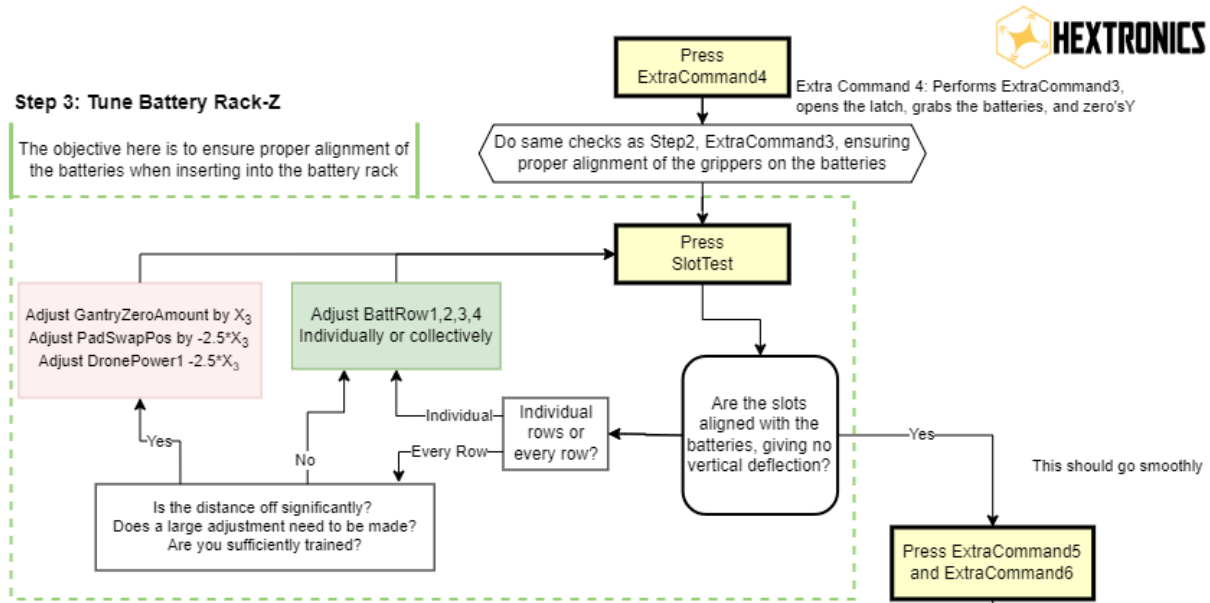

Battery Rack Z-axis Tuning Flow Chart

1. Run the **ExtraCommand4** procedure to command the gantry to remove the drone's batteries and return them to the zero-Y position.

- The **ExtraCommand4** button is located in the **Testing Commands** sub-menu in the **calibration** tab.
- Inspect the gantry to ensure proper alignment with the grippers and batteries.⁸
- Use the **Abort** command if the gantry collides with other components.

2. Press **SlotTest** command and observe the alignment between the batteries and each slot on the battery rack. If the batteries are aligned with each slot, continue to step 5. If the batteries are not aligned, proceed to step 3.

- Use the **Abort** command if the gantry or batteries collide with other components.
- The **SlotTest** button is located in the **Testing Commands** sub-menu in the **Calibration** tab.

⁸ If unaligned, reference step 2 of Pad-Z and Gantry-Y calibration procedure (previous procedure)

3. If the alignment is off on *INDIVIDUAL* slots, adjust **BattRow1,2,3,4** individually or collectively based on which rows are unaligned. Run **SlotTest** and observe the changes applied.

- Repeat this step until proper alignment is obtained.
- **BattRow1,2,3** and **4** are located in **Battery Swap Settings** in the **General Offsets** menu.
- If the batteries are aligned with all rows, continue to step 5.

4. If the alignment is off significantly on *ALL* rows and a large adjustment needs to be made, Adjust **GantryZeroAmount** by $X3$, Adjust **PadSwapPos** by $-2.5 \times X3$, and Adjust **DronePower1** $-2.5 \times X3$. Run **SlotTest** and observe the changes applied.

- Repeat this step until proper alignment is obtained.
- **GantryZeroAmount**, **Adjust PadSwapPos**, and **Adjust DronePower1** commands are located in the **General Offsets** menu.
- Once the batteries are aligned with all rows, continue to step 5.

5. Run **ExtraCommand5** to bring the gantry up and to the drone right before the battery insertion procedure with "Carefulln", then run **ExtraCommand6** to finish swap, insert the batteries into the drone, and twist the latch.

- Apply Pad Offset O1 To DronePower1

Power Cycle

Calibrate the power cycle routine for the station.

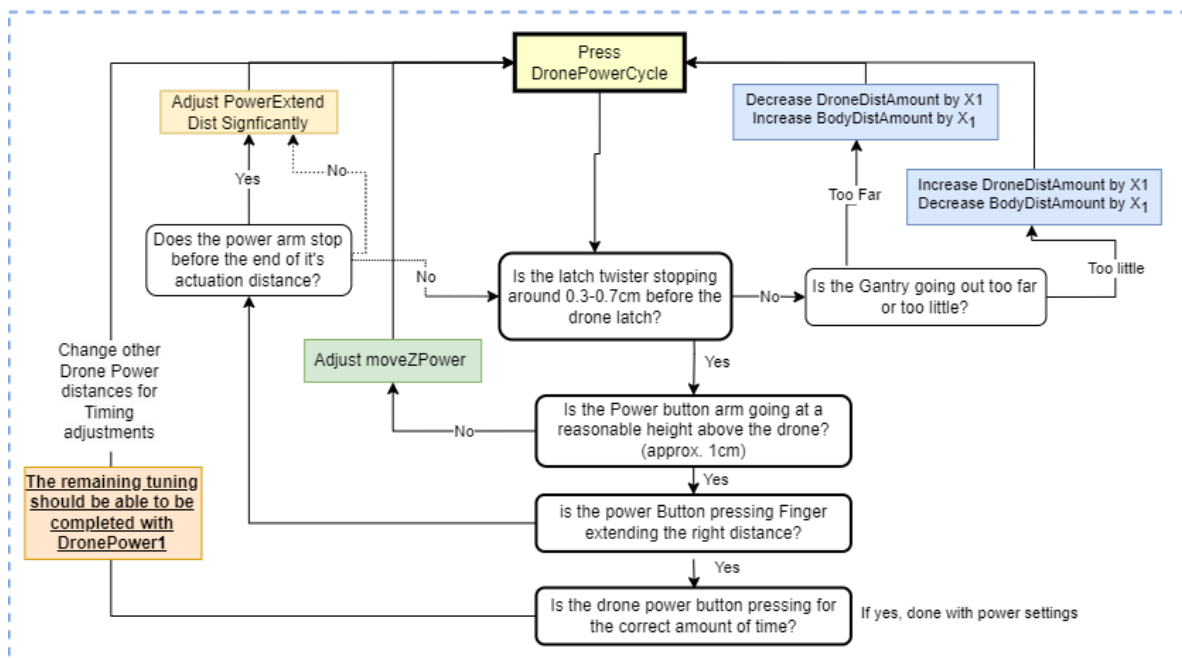

Power Cycle Tuning Flow Chart

1. Run **PowerDroneToggle** command and carefully observe the gantry's 3d printed latch twister. The latch twister should stop around 0.3-0.7cm before the drone latch. If this is the case, continue to step 2. If the 3D-printed latch twister stops too close to the drone latch, decrease **DroneDistAmount** by X1 and increase **BodyDistAmount** by X1. Then run **Power Drone Toggle** again to observe changes. If the 3D-printed latch twister stops too far from the drone latch, increase **DroneDistAmount** by X1 and decrease **BodyDistAmount** by X1. Then run **Power Drone Toggle** again to observe changes.

- **PowerDroneToggle** command is located in the **Testing Commands** tab on the **Advanced** menu.
- **DroneDistAmount** and **BodyDistAmount** commands are located in **General Offsets-Primary** settings.
- Use the **Abort** command if the gantry or power button rod collides with other components.
- Repeat this step until the distance is correct.

2. Once the latch twister distance has been confirmed appropriate, observe if the Power Button Arm is at a reasonable height above the drone⁹. If the height is appropriate, continue to step 3. If not, adjust **moveZPower** then run power drone toggle again to observe changes.

- **moveZPower** is located in **Power Cycle Settings** in **General Offsets**.
- Use the **Abort** command if the gantry or power button rod collides with other components.
- Repeat this step until the height is correct.

3. Observe if the 3d-printed power button presser is extending the correct distance. It should be directly over the drone's power button. If the distance is correct, continue to step 4. If the 3d-printed button presser is not aligned with the drone's power button, adjust **PowerExtend Dist** significantly, then run **Power Drone Toggle** again to observe changes.

- **PowerExtend Dist** is located in **Power Cycle Settings** in **General Offsets**.
- Use the **Abort** command if the Gantry or power button rod collides with other components.
- Repeat this step until the distance is correct.

⁹ Approximately 1 cm

4. Observe whether or not the drone power button is being pressed for the correct amount of time to power on/off the drone. If yes, the power cycle has been successfully calibrated. If not, adjust **DronePower1** until the timing is sufficient to power toggle the drone. Additionally, you can change other Drone Power distances for timing adjustments.

- DronePower1 is located in **Power Cycle Settings** in **General Offsets**.
- Use the **Abort** command if the gantry or power button rod collides with other components.
- Repeat this step until the timing is correct.

Fine-Tune Swap

Clean up and tune the last adjustments of the swap routine.

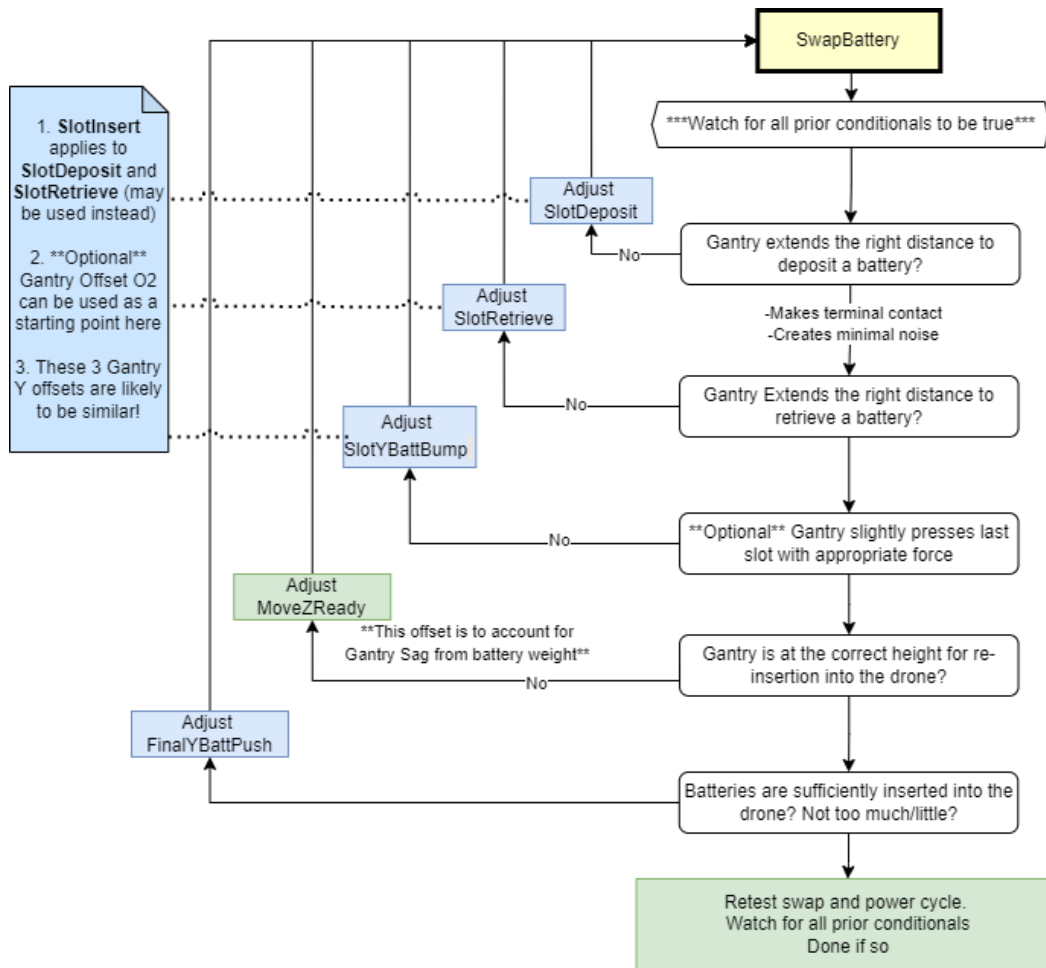

Final Tuning Adjustments Flow Chart

Variable Descriptions

| Offset Value Name | Description |
|-------------------------------|--|
| Power Cycle Settings | |
| DroneDistAmount | Distance the gantry goes from zero to go to the drone, but stops before the latch can make contact |
| BodyDistAmount | Remaining distance to get the gantry to the drone batteries |
| DronePower1 | The raising of the pad initially to the power button first press |
| DronePower2 | The lowering of the pad away from the button |
| DronePower3 | The raising of the pad to contact the button again |
| DronePower4 | The lowering of the pad away from the button |
| PowerExtend | The distance in which the power button finger extends |
| PowerRetract | The distance in which the power button zero's |
| PowerStallCycle | Time between stall guard checks |
| PowerStallMax | Dynamics stall guard max threshold for current detection reading |
| PowerStall | Stall threshold |
| PowerSGUnlock | "1" means that stall guard threshold is dynamic, "0" means it is static |
| PowerStallDelay | Time in Milliseconds before Stall Guard kicks in |
| Battery Swap Variables | |
| SlotInsert | The initial distance of the Y gantry to insert the battery into a row |
| SlotDeposit | The distance the Y gantry goes to deposit a battery |
| SlotRetrieve | The distance the Y gantry goes to retrieve a battery |
| SlotYBattBump | The gantry Y distance to push the last batteries placed in a bit more |
| BattRow1 | The gantry z distance of the 1st battery row |
| BattRow2 | The gantry z distance of the 2nd battery row |
| BattRow3 | The gantry z distance of the 3rd battery row |
| BattRow4 | The gantry z distance of the 4th battery row |
| ShimOut | The gantry Y distance to move while unfolding gripper fingers off of batteries |
| ShimIn | The gantry Y distance to move while wrapping gripper fingers around batteries |
| CarefulDistAmount | The distance in which we are checking for gantry Y stall during battery insertion/retrieval |
| PadSwapPosAmount | The height of the pad for swapping |
| MoveZOut | Now 0 |

| | |
|----------------------------|---|
| MoveZReady | Now 0 |
| MoveZFinal | Now 0 |
| FinalYBattPush | Final, extra push on the drone to fully insert the batteries |
| FinalYBattLock | Final retraction away from the drone to turn the latch distance |
| Pad Settings | |
| PadSpeedAmount | Pad speed |
| PadFull | The first step of the pad raising sequence |
| PadExtra | The second step of the pad raising sequence |
| PadTimeout | Time before the pad fails to zero |
| PadOffset | A constant that is added to the pad Z height after zeroing for swapping |
| Gantry Startup | |
| ZOffsetConstant | Used to offset zero of gantry |
| ZSpeedAmount | Gantry Z speed |
| ZTimeout | Time before the gantry fails to zero |
| YExtensionAmount | Not used |
| YSpeedAmount | Gantry Y speed |
| YSlowAmount | Gantry speed for careful operations |
| YStallCycle | Time between stall guard checks |
| YStallMax | Dynamic stall guard max threshold for current detection reading |
| YStall | Gantry Y stall threshold |
| YSGUnlock | "1" means that stall guard threshold is dynamic, "0" means it is static |
| YStallDelay | Time before stall detection is activated |
| GantryZeroAmount | Distance the gantry moves after zero |
| DC Motor Settings | |
| RoofDist | The distance the roof tries to move to open and close |
| RoofDutyCycle | The speed of the roof |
| FullClose | The gripper closing distance |
| FullOpen | The gripper opening distance |
| Centering Variables | |
| LatStallCycle" | Time between stall guard checks |
| LongStallCycle" | Time between stall guard checks |

| | |
|---------------------------|---|
| LatStallMax" | Dynamic stall guard max threshold for current detection reading |
| LongStallMax" | Dynamic stall guard max threshold for current detection reading |
| LatStall | Stall guard threshold |
| LongStall | Stall guard threshold |
| CenterSpeedAmount | Centering motor speed |
| CenterAccelAmount | Centering motor speed |
| LatDistAmount | Lateral centering distance |
| LongDistAmount | Longitudinal centering distance |
| LatSGUnlock | "1" means that stall guard threshold is dynamic, "0" means it is static |
| LongSGUnlock | "1" means that stall guard threshold is dynamic, "0" means it is static |
| Latch Variables | |
| LatchSpeedAmount | Latch speed |
| LatchStallCycle | Time between stall guard checks |
| LatchStallMax | Dynamic stall guard max threshold for current detection reading |
| LatchStall | Stall guard threshold |
| LatchSGUnlock | "1" means that stall guard threshold is dynamic, "0" means it is static |
| LatchStallDelay | Time before stall guard starts checking |
| Interval Movements | |
| RoofMovement | Interval movement |
| PadMovement | Interval movement |
| GantryMovement | Interval movement |
| YMovement | Interval movement |
| SwapPosition1 | Interval movement |
| ADVANCED Variables | |
| CenterRMS | Root-mean-squared current rating |
| YRMS | Root-mean-squared current rating |
| PadRMS | Root-mean-squared current rating |
| ZRMS | Root-mean-squared current rating |
| ExtensionRMS | Root-mean-squared current rating |
| LatchRMS | Root-mean-squared current rating |
| CenterMicrosteps | Microsteps of the stepper motor |

| | |
|---------------------|---------------------------------|
| YMicrosteps | Microsteps of the stepper motor |
| PadMicrosteps | Microsteps of the stepper motor |
| ZMicrosteps | Microsteps of the stepper motor |
| ExtensionMicrosteps | Microsteps of the stepper motor |
| LatchMicrosteps | Microsteps of the stepper motor |

Station Calibration: Flow Chart

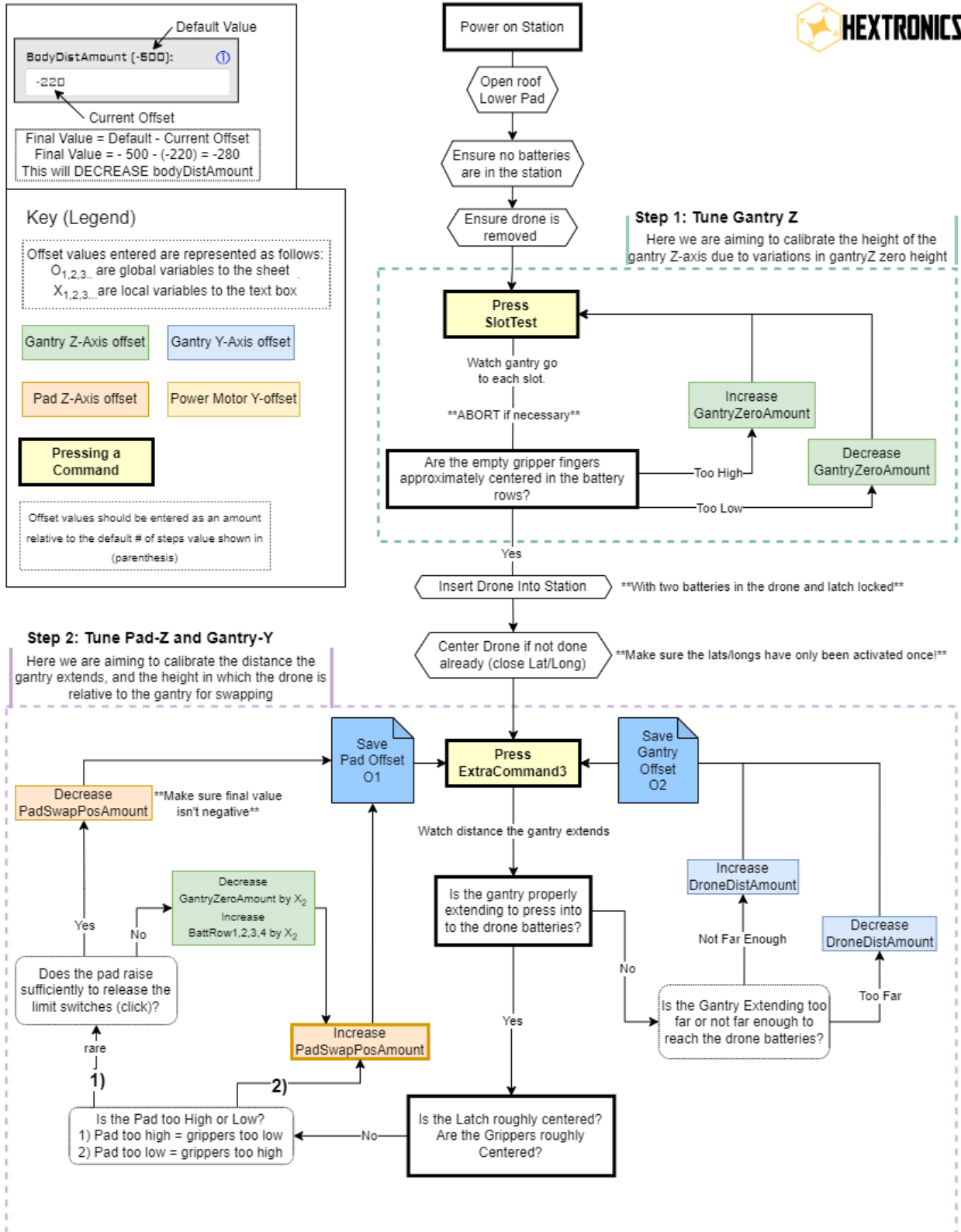



Step 3: Tune Battery Rack-Z

The objective here is to ensure proper alignment of the batteries when inserting into the battery rack

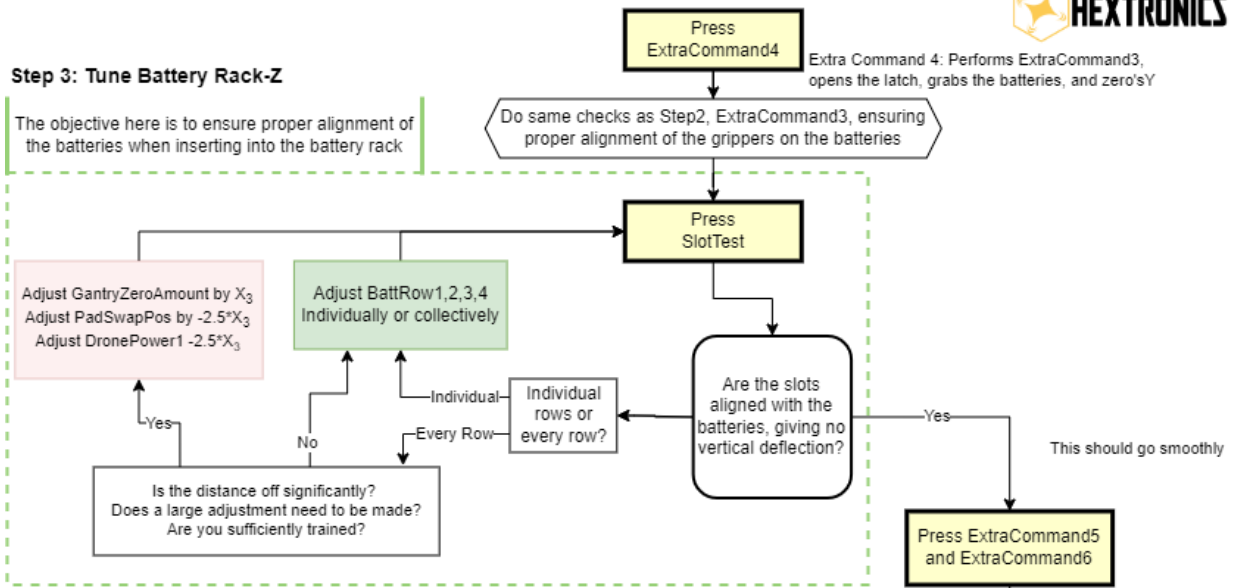

Step 4: Tune PowerCycle

Here we are aiming to calibrate the power cycle routine for the station

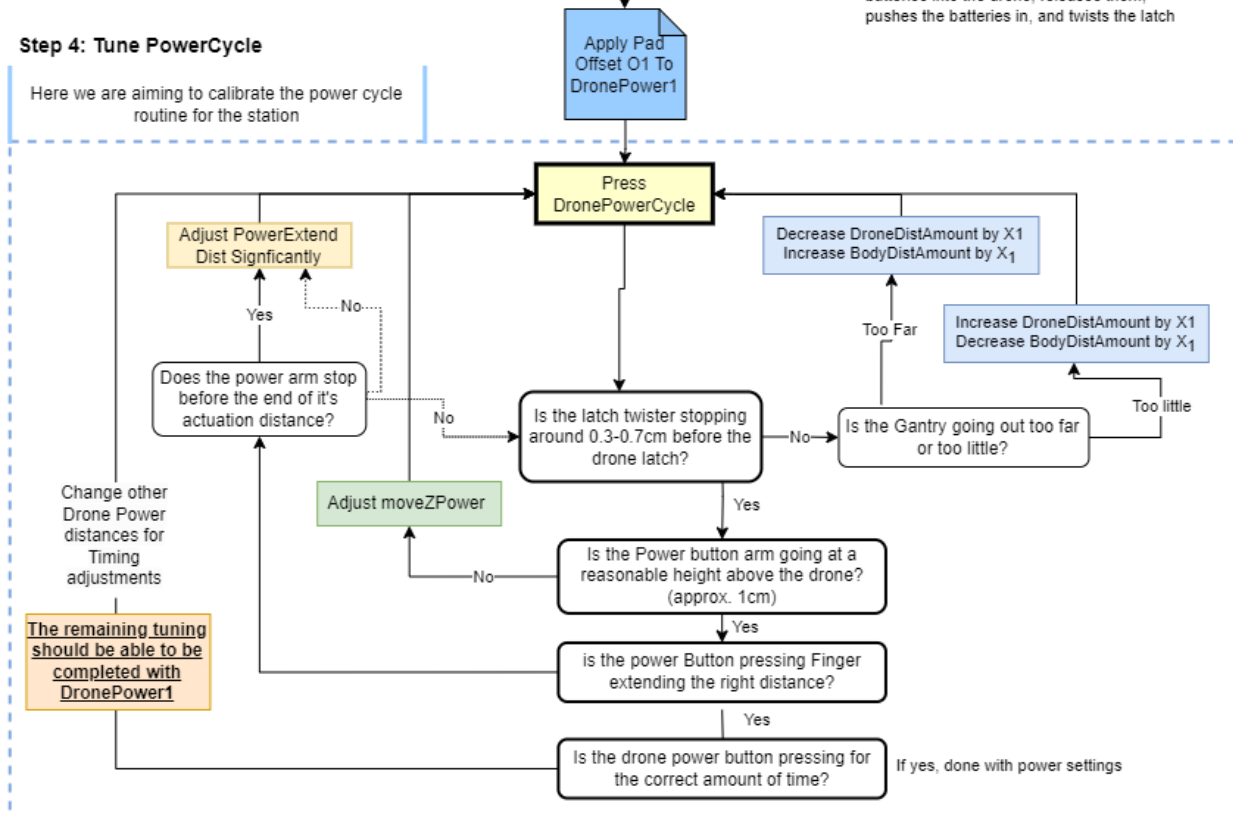



Step 5: Fine-Tune Swap

The objective here is to clean up and tune the last, relatively minor adjustments of the swap routine

- 1. SlotInsert applies to SlotDeposit and SlotRetrieve (may be used instead)
- 2. ****Optional**** Gantry Offset O2 can be used as a starting point here
- 3. These 3 Gantry Y offsets are likely to be similar!

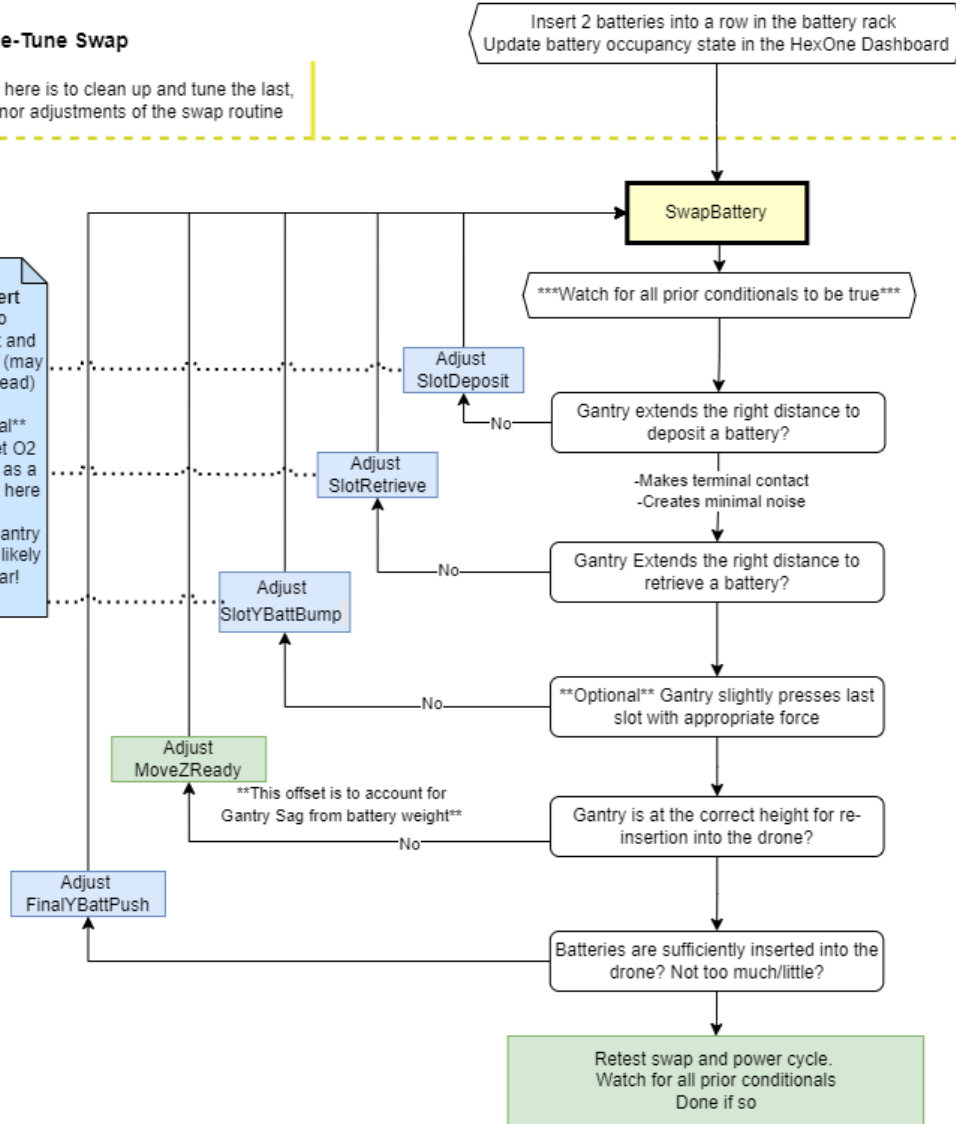

Station Calibration: Swap Logic Diagram

Atlas 300 Swap Logic

Rev. 1 Date: 9/13/22 Nicholas Mulka

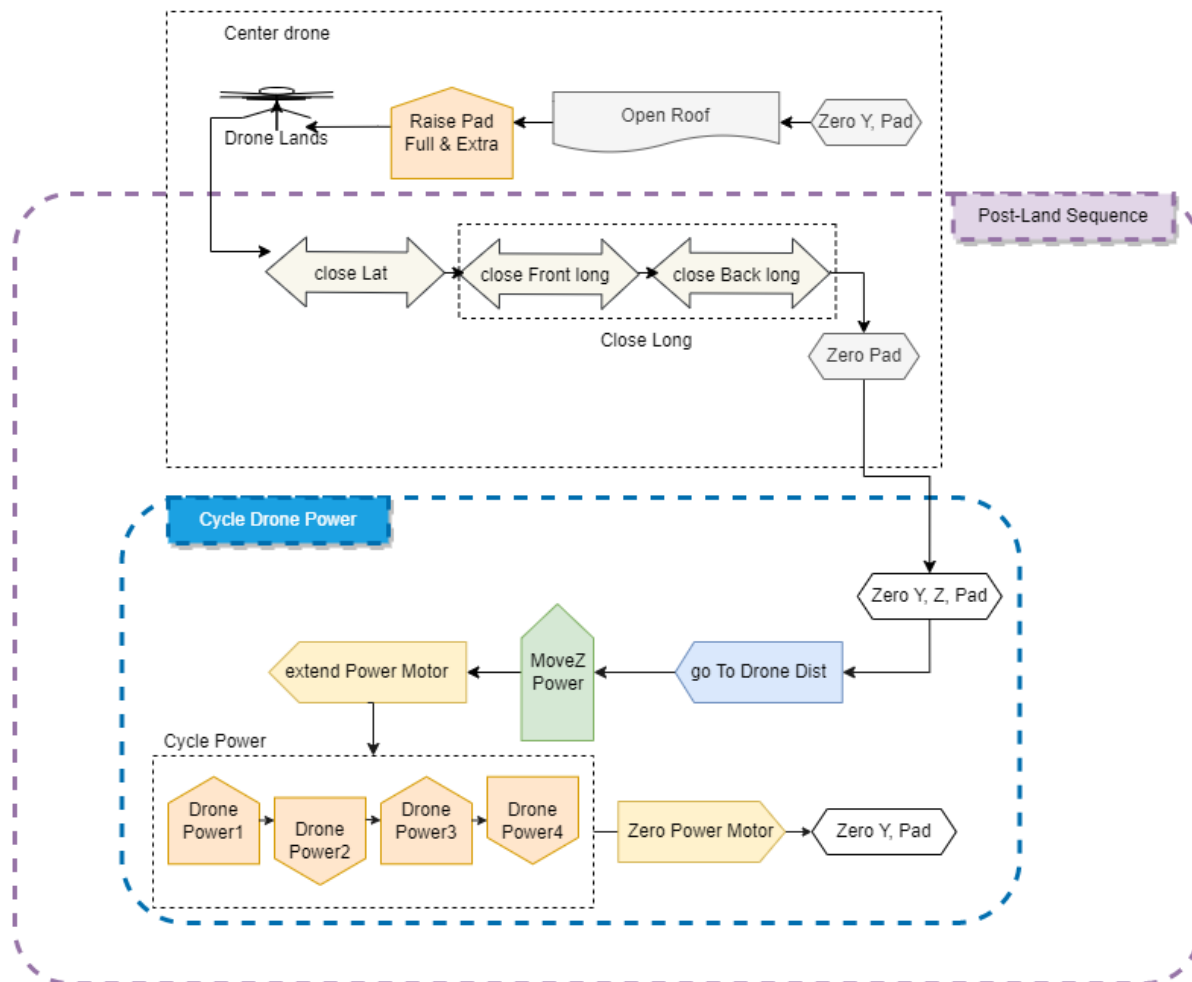
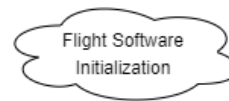
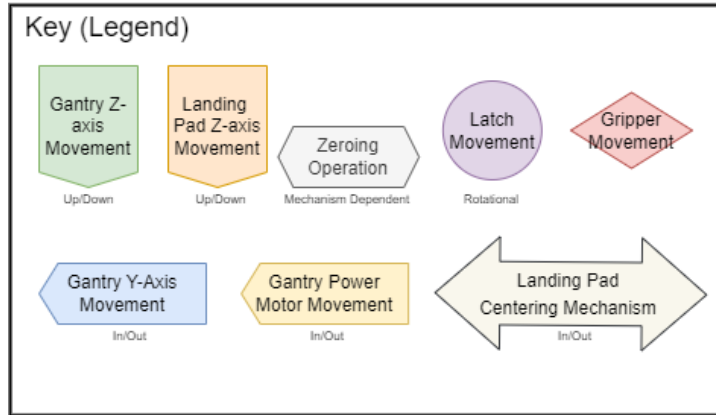

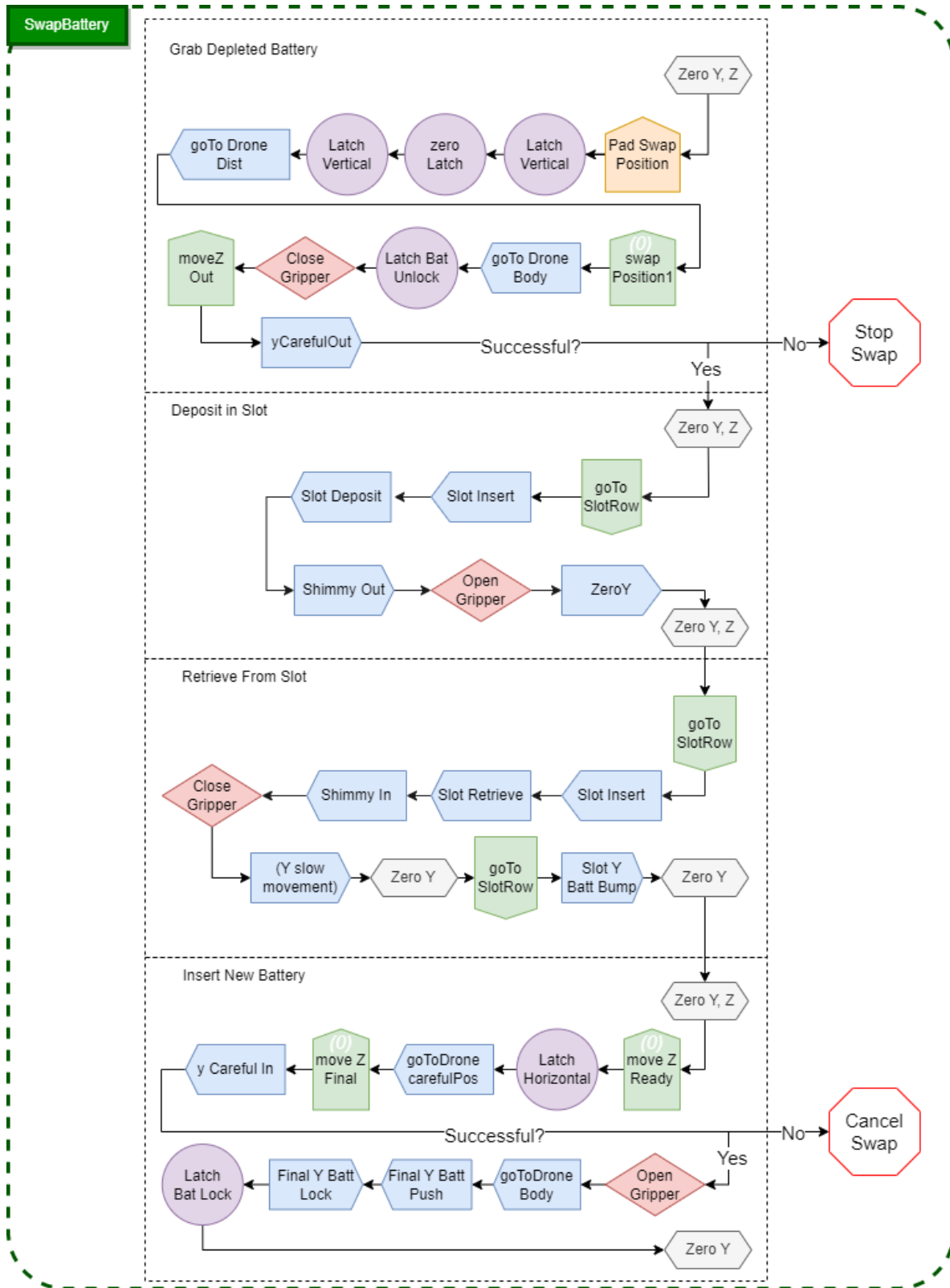

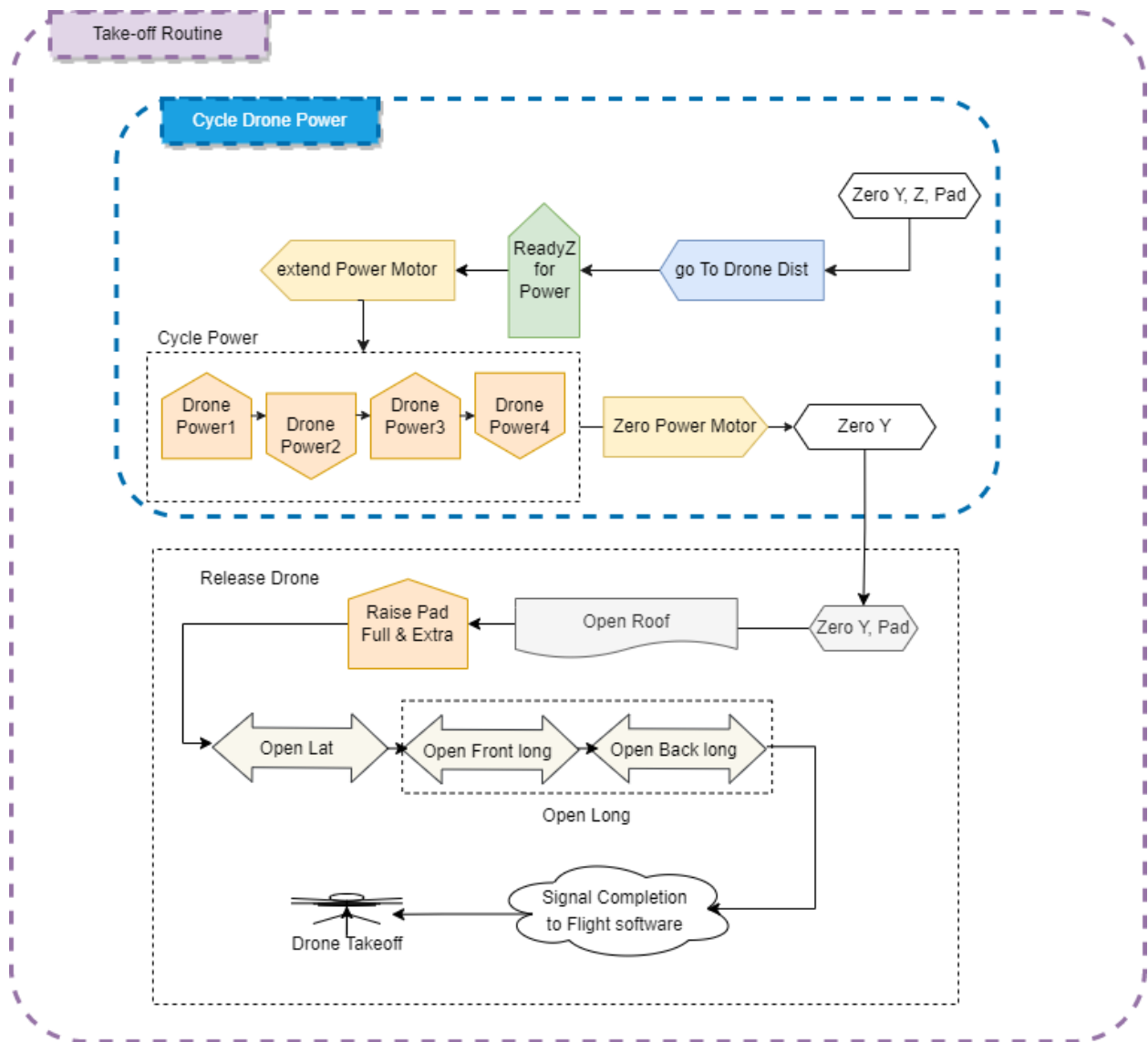

FlytNow Operations

Create a FlytNow Account

Please contact Support@Flytbase.com for assistance with account creation or Support@Hextronics.tech for assistance locating your unique UDC code.

Step by step:

1. If you do not already have a FlytNow account, go to <https://app.flytnow.com/signup> to create one.
2. Once you verify the email, share the email you used with team FlytBase at support@flytbase.com.

Pre/Post flight Inspection

Preflight Inspection

- The weather is all clear
- Confirmed power & ethernet connection
- Pad has opened and raised pad (ON PRIME?)
- Drone is correct on the pad
- Drone props are all present and in good condition
- Drone does not have rubber foot guards on
- Drone battery is in good position & above a certain %

Postflight Inspection

- Drone has safely landed on the pad
- Drone was lowered into the station & retracted props
- Roof was closed after the pad was lowered

Registering Drone Station

Follow the instructions below **in order**. Once you have reached the end of this section, please proceed to the "AWS Photo/Video Bucket Setup" section.

1. Login into the FlytNow dashboard

<https://app.flytnow.com/login>

2. Power cycle the station

- Remove and re-insert main power cable, this will clear the timeframe window for registration and provide a fresh 15 minutes.

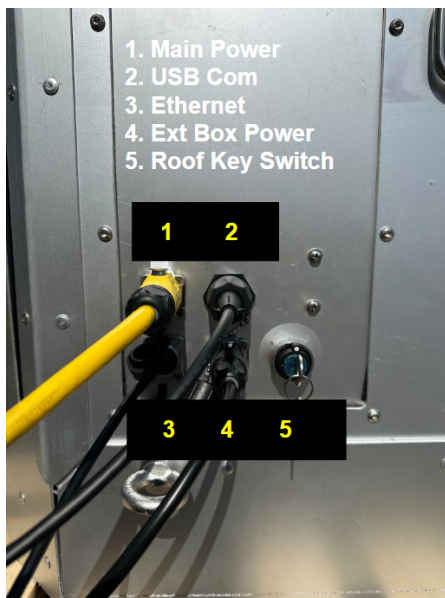

3. Turn on RC

- Manually press the solenoid to power ON the RC.



4. Turn on drone using **Power Drone Toggle** button in the center panel of the **Atlas Commands** page
5. Enter FlytNow and select **Add Device** from the dashboard tab
6. Select **Setup DIAB** in the bottom left corner of the window and follow the on-screen prompts until completion.
7. Bind drone when prompted
 - When the FlytNow **Setup Diab** process prompts you to link the drone, please press and hold the drone power button for 5 seconds to link the drone to the RC.

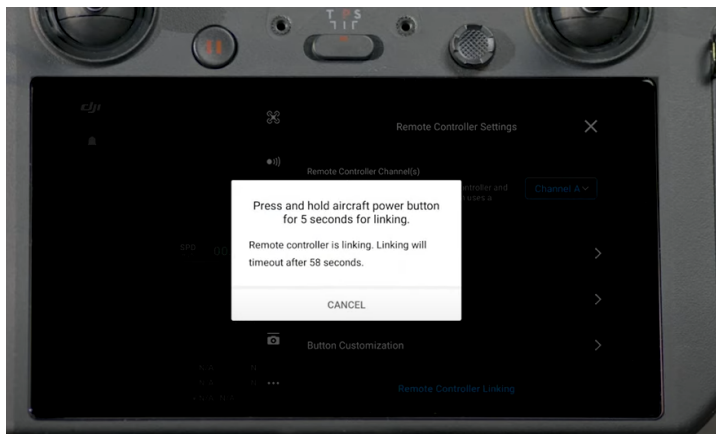

8. Once DIAB setup is complete confirm that your station is the **Devices Added** tab on the Flytnow dashboard

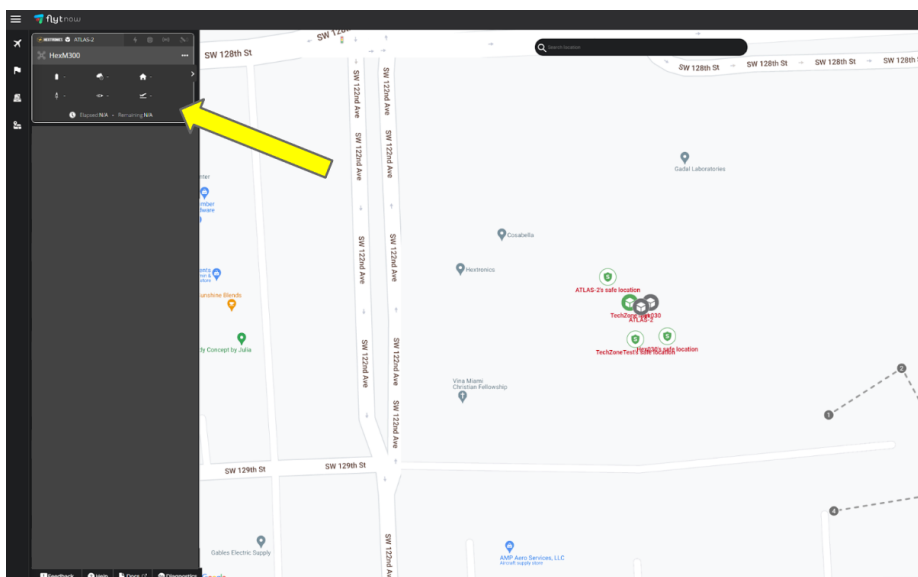

Linking Drone

Once you have registered, follow the steps below in order to link your drone to the station.

1. On the FlytNow dashboard go to settings

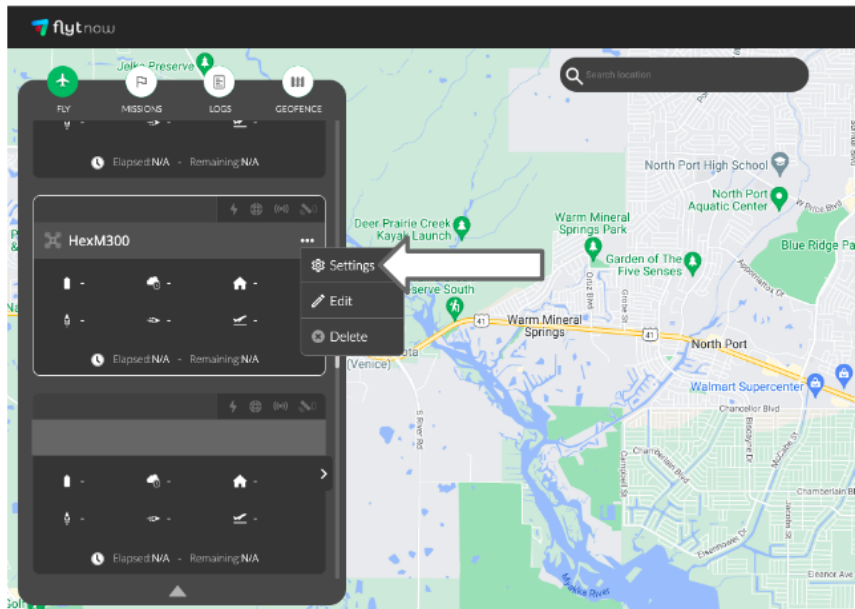

2. Select your drone from the drop down menu

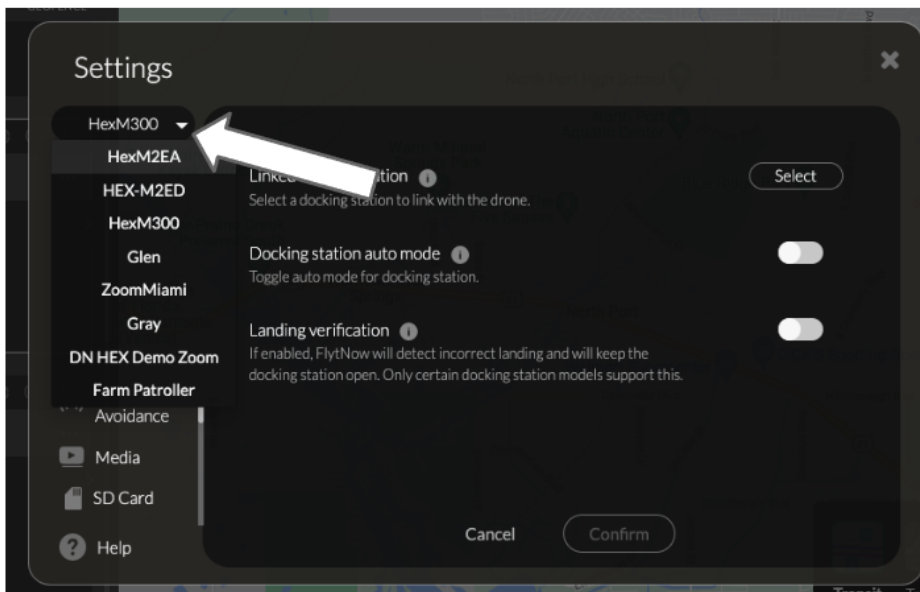

3. Select your docking station from within the drop down menu

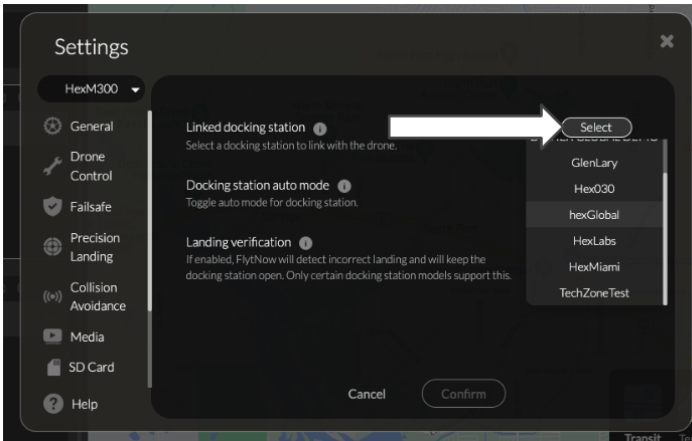

4. Edit docking station location

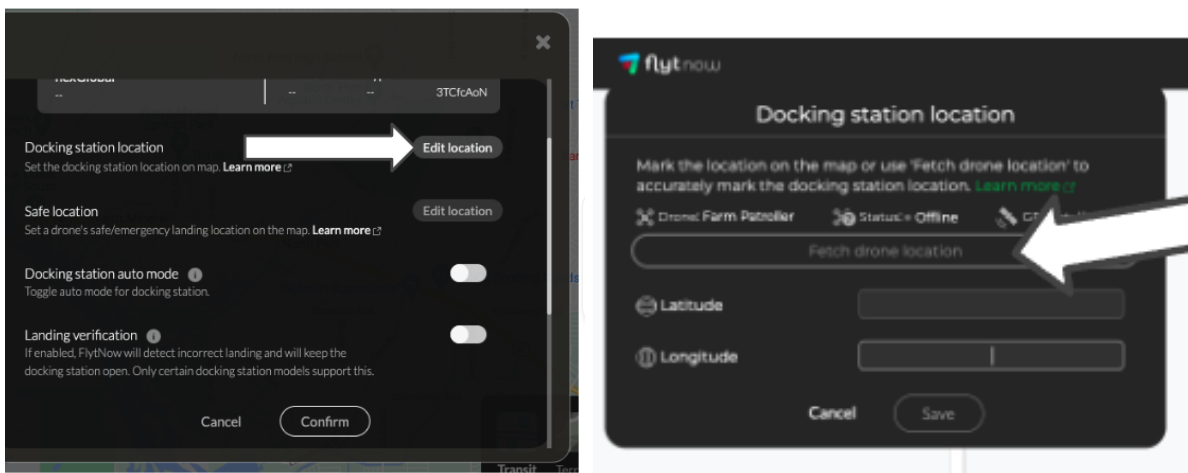

- Open the roof and power on the drone to fetch its location
 - This is the most accurate way to get to the docking station location and improve overall precision landing efficiency

5. Edit safe location

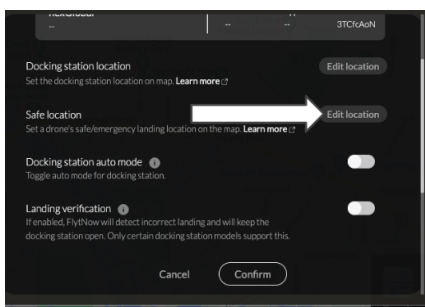

- Place your drone in the safe physical location you desire for it to land
OR
Select an area on the map free of any obstructions, structures and trees¹⁰

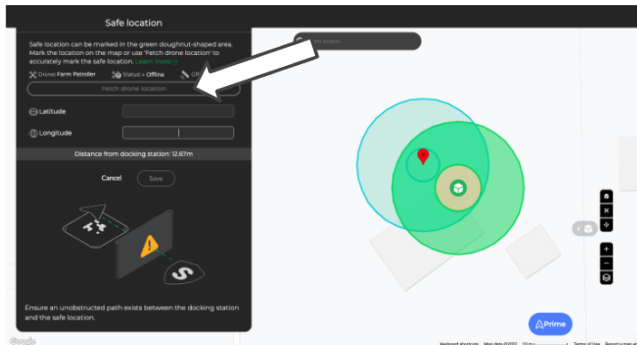

6. Enable auto mode & landing verification, then select save changes.
 - Select the tab to enable (green) **Docking station auto mode**
 - Select the tab to enable (green) **Landing verification**
 Once all settings have been edited, you can **Confirm** changes.

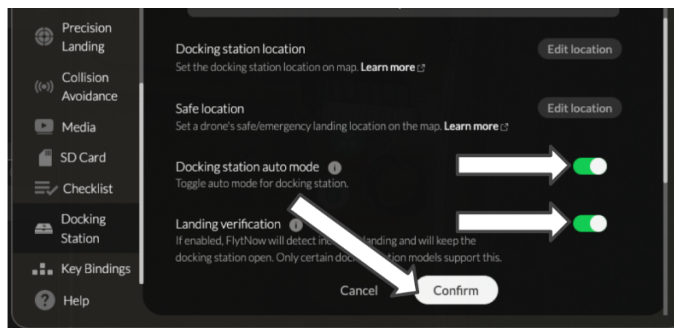

Cloud Media Sync

FlytNow allows for seamless synchronization of drone media to personal cloud storage, ensuring operator privacy and convenience.

Private Cloud Storage

FlytNow allows the operator to integrate their own private cloud storage for archiving drone videos and images. FlytNow does not maintain any copies of the user's drone videos to ensure privacy. To save and replay videos and images, the operator has to set up an AWS S3 bucket.

¹⁰ Use the satellite view to observe topography changes

AWS S3 Setup

1. Sign in or create an AWS account: <https://aws.amazon.com/>
2. Go to the **Bucket** tab in the Amazon S3 console. Click on Create Bucket to create a bucket in the preferred region.

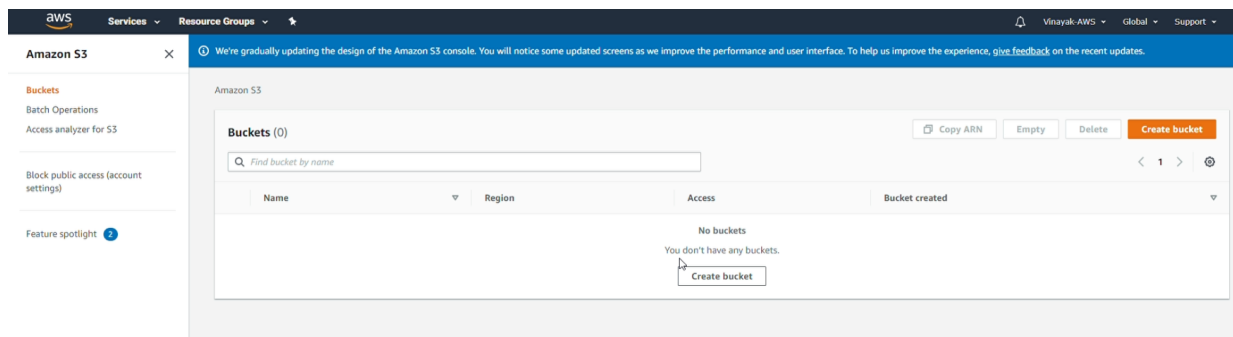

3. Enable the ACLs and select the object ownership to **Bucket owner preferred**.

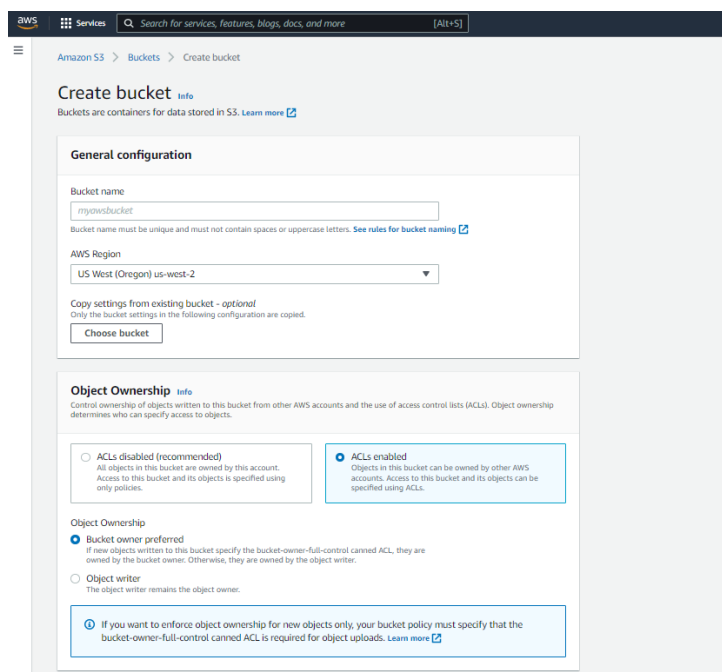

- Next, ensure that **Block all public access** is set to **off**.

Block Public Access settings for this bucket

Public access is granted to buckets and objects through access control lists (ACLs), bucket policies, access point policies, or all. In order to ensure that public access to this bucket and its objects is blocked, turn on Block all public access. These settings apply only to this bucket and its access points. AWS recommends that you turn on Block all public access, but before applying any of these settings, ensure that your applications will work correctly without public access. If you require some level of public access to this bucket or objects within, you can customize the individual settings below to suit your specific storage use cases. [Learn more](#)

- Block all public access**
Turning this setting on is the same as turning on all four settings below. Each of the following settings are independent of one another.
- Block public access to buckets and objects granted through new access control lists (ACLs)**
S3 will block public access permissions applied to newly added buckets or objects, and prevent the creation of new public access ACLs for existing buckets and objects. This setting doesn't change any existing permissions that allow public access to S3 resources using ACLs.
- Block public access to buckets and objects granted through any access control lists (ACLs)**
S3 will ignore all ACLs that grant public access to buckets and objects.
- Block public access to buckets and objects granted through new public bucket or access point policies**
S3 will block new bucket and access point policies that grant public access to buckets and objects. This setting doesn't change any existing policies that allow public access to S3 resources.
- Block public and cross-account access to buckets and objects through any public bucket or access point policies**
S3 will ignore public and cross-account access for buckets or access points with policies that grant public access to buckets and objects.

 **Turning off block all public access might result in this bucket and the objects within becoming public**
AWS recommends that you turn on block all public access, unless public access is required for specific and verified use cases such as static website hosting.

I acknowledge that the current settings might result in this bucket and the objects within becoming public.

- Ensure that **Bucket Versioning** and **Default Encryption** are set to **Disable**.

Bucket Versioning

Versioning is a means of keeping multiple variants of an object in the same bucket. You can use versioning to preserve, retrieve, and restore every version of every object stored in your Amazon S3 bucket. With versioning, you can easily recover from both unintended user actions and application failures. [Learn more](#)

Bucket Versioning

Disable

Enable

Tags (0) - optional

Track storage cost or other criteria by tagging your bucket. [Learn more](#)

No tags associated with this bucket.

Default encryption

Automatically encrypt new objects stored in this bucket. [Learn more](#)

Server-side encryption

Disable

Enable

6. Now click on **Create bucket**.
7. Once the organizer has successfully created the bucket, go to **Bucket Name > Properties > Enable Transfer acceleration**.

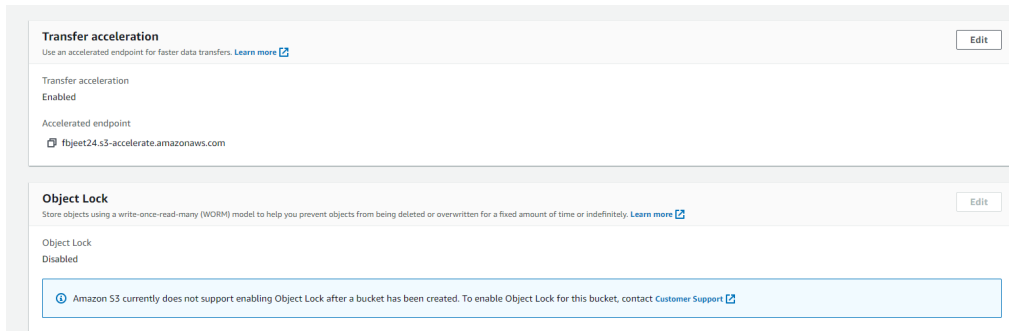

8. Now go to **Bucket Name > Permissions > Bucket Policy**. Paste the following JSON and replace the **Bucket_Name** with the actual name of the bucket.

```
{
  "Version": "2012-10-17",
  "Id": "Policy1586431420805",
  "Statement": [{
    "Sid": "Stmnt1586431413927",
    "Effect": "Allow",
    "Principal": {
      "AWS": "arn:aws:iam::338532100127:user/S3-FlytNow"
    },
    "Action": "*",
    "Resource": [
      "arn:aws:s3:::Bucket_Name",
      "arn:aws:s3:::Bucket_Name/*"
    ]
  }]
}
```

Bucket policy

The bucket policy, written in JSON, provides access to the objects stored in the bucket. Bucket policies don't apply to objects owned by other accounts. [Learn more](#)

Edit Delete

```

{
  "Version": "2012-10-17",
  "Id": "Policy1586431420805",
  "Statement": [
    {
      "Sid": "Stmt1586431413927",
      "Effect": "Allow",
      "Principal": {
        "AWS": "arn:aws:iam::338532100127:user/S3-FlytNow"
      },
      "Action": "*",
      "Resource": [
        "arn:aws:s3:::fbjeet24",
        "arn:aws:s3:::fbjeet24/*"
      ]
    }
  ]
}

```

Copy

- Finally, proceed to **Bucket Name > Permissions > CORS Configuration**. Paste the following array to update the **CORS configuration**.

```

[
  {
    "AllowedHeaders": [
      "*"
    ],
    "AllowedMethods": [
      "GET"
    ],
    "AllowedOrigins": [
      "*"
    ],
    "ExposeHeaders": [],
    "MaxAgeSeconds": 1800
  }
]

```

Cross-origin resource sharing (CORS)

The CORS configuration, written in JSON, defines a way for client web applications that are loaded in one domain to interact with resources in a different domain. [Learn more](#)

Edit

```
[
  {
    "AllowedHeaders": [
      "*"
    ],
    "AllowedMethods": [
      "GET"
    ],
    "AllowedOrigins": [
      "*"
    ],
    "ExposeHeaders": [],
    "MaxAgeSeconds": 1800
  }
]
```

Copy

10. Once completed, please send the **S3 Bucket Name** with the **AWS region** over email to support@flytbase.com.

How To Create Missions

1. To begin flight operations, login to the FlytNow Dashboard. (Using your new username/password)
2. On the **Missions** tab, select **Add Mission**.

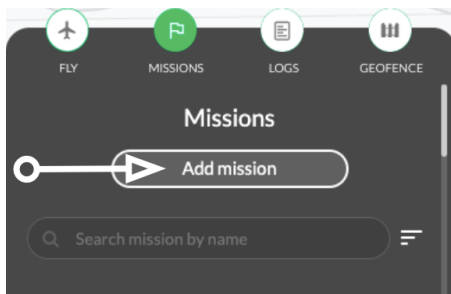

3. Select **Create S Path Mission**.

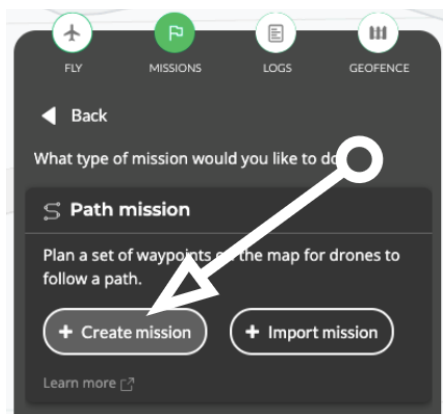

4. Change Mission speed to 6m/s¹¹.

* The maximum speed is 15m/s. Will not operate beyond that.

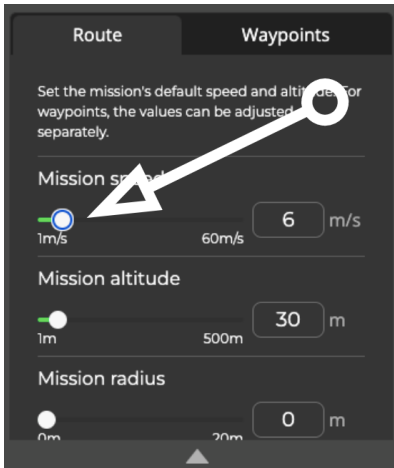

5. Raise the Mission altitude to at least 30m or more depending on your terrain¹².



6. Name your mission.

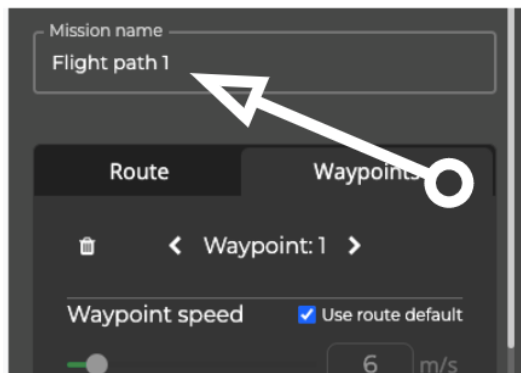

¹¹ This is a safe entry-level speed at 13 mph

¹² Stay well above the treeline and topography changes

7. Scroll down and select **Return to Docking Station** from the **Finish** action drop down menu.

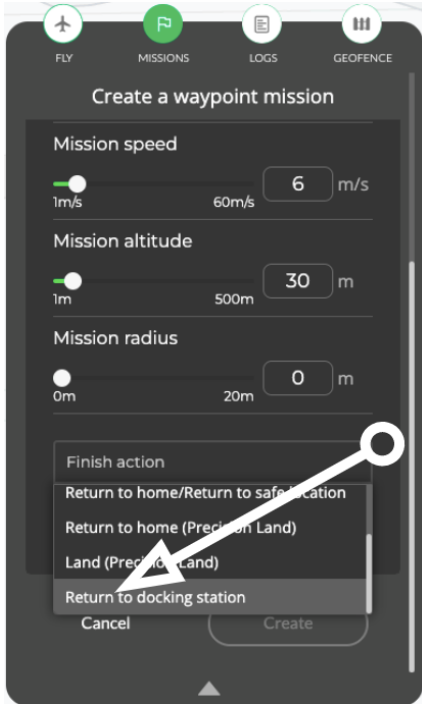

8. Make the first waypoint close to the docking station

- * **Note:** Click the map to add waypoints

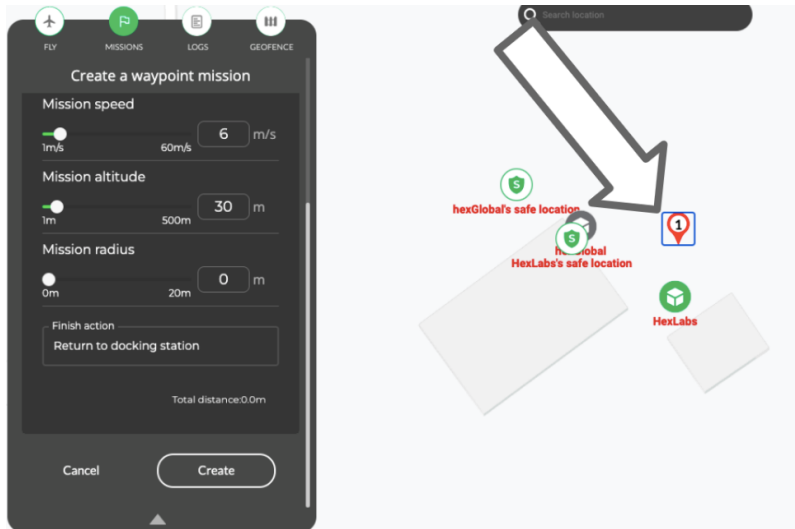

9. Create your flight path using multiple waypoints

- * **Note:** Make the last waypoint near the docking station

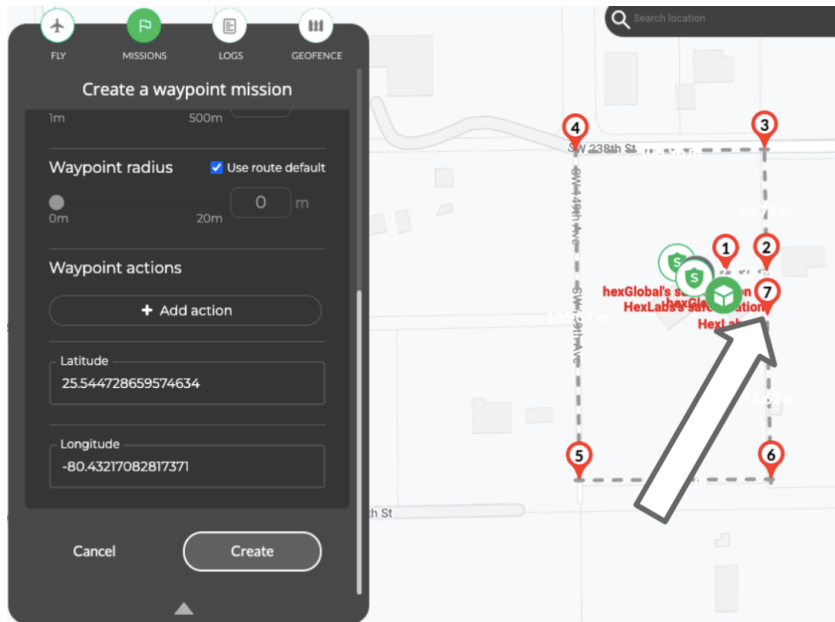

10. Select **Create** & Save mission after completing your flight route

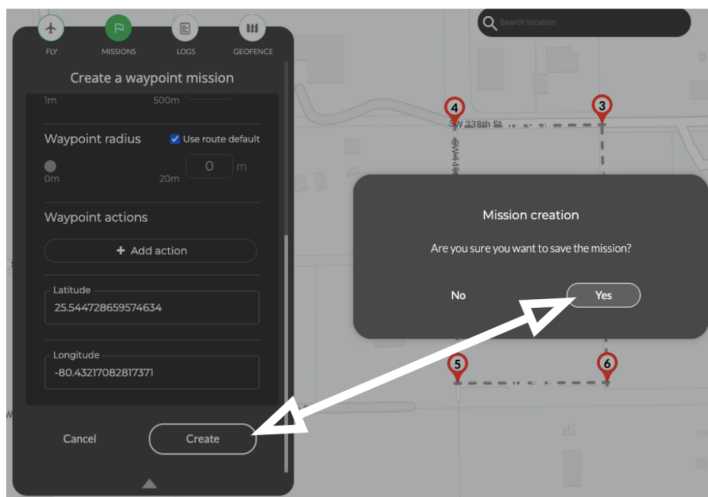

Mission creation is now complete. You can now find and edit your missions within the **Missions** tab on the dashboard.

How To Fly

Flight tips:

- Confirm station is powered ON. Although not required, power cycling the station beforehand can be beneficial for a fresh connection.
- Refresh **FlytNow** web browser at the start of operations
- Log onto the **Hextronics Dashboard** to confirm the station is online
- **Priming** before a flight will provide a quicker manual takeoff
- Always allow **Pre-Flight Routine** to complete
- Always allow **Post-Flight Routine** to complete before starting a new mission.
- Familiarize yourself with the flight area for obstacles and altitude changes before creating a mission.
- Flight waypoints should not bunch up too close to one another
- First and last waypoints should be near the docking station home location
- Use **FlytNow** utility window for station handling such as **open/close, battery swap, etc**

Photo/video action tips:

- For **Capture image & Start Video** waypoint action the drone will always face and capture towards the next waypoint.

Gimbal pitch action inputs:

- 0° looks directly forward
- -45° is a neutral forward/down view
- -90° looks directly down
- Adjust the value + or - for optimal pitch angle

WET DRONE emergency landing - (WITHOUT battery swap):

Use this **FlytNow** sequence via the **Utility** window & **Flight Controls** to dock the drone without any battery swapping operations - This is used if the drone has been rained on during a mission, in order to dock the drone without inserting the WET drone battery into the station charging slots.

- Select **Abort** current mission
- Manually fly the drone over the docking station / OR /Select **RTDS** and select **Abort** again when the drone is nearly above the docking station to cancel the sequence
- Select **Open Enclosure** to open the pad
- Select **Precision Land** when the drone is above the station
- Select **Close Lat & Long**
- Select **Lower Pad**
- Select **Close Enclosure** once the drone has safely landed and is positioned on the pad

Note: This sequence will prompt the drone to land on the pad and be inserted into the station for housing but NOT proceed to remove the wet battery from the drone for battery swap operations.

Take manual control:

Please reference the 3 manual control options below.

1. Keyboard

- Keyboard controls:

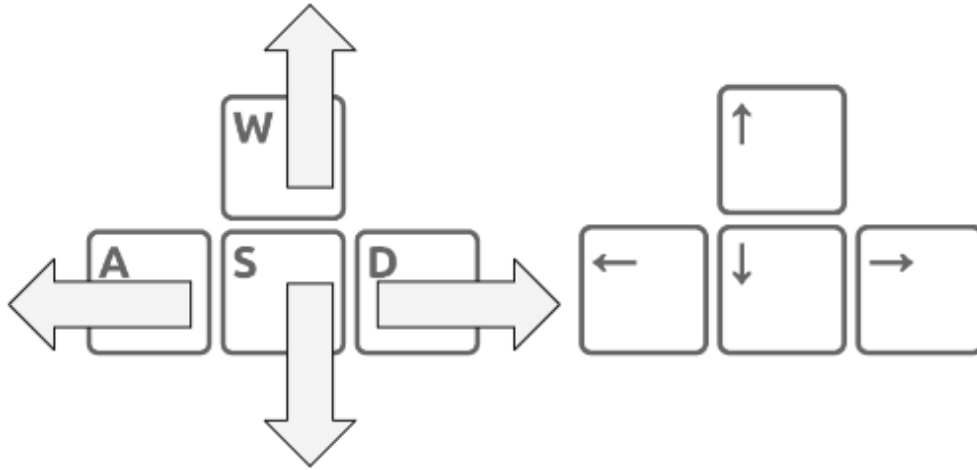

2. XBOX controller

- XBOX controls:



3. On-screen

- Take manual control mid-flight in the drone FPV view by clicking the **Joystick icon** (middle bottom of the FlytNow screen)
- Click the icons to change method of control (Keyboard / On-screen / External controller)
- Select **Resume/abort** mission to continue (bottom right toolbar)
- Select **Return to the docking station** to land the drone
- On-screen controls:



Drone Control

- **Pitch forward**
- **Pitch backward**
- **Yaw left**
- **Yaw right**

Gimbal Control

- **Pitch up**
- **Pitch down**
- **Yaw left**
- **Yaw right**

Maintenance

This section describes the maintenance procedures for the Atlas and Matrice 300 drone

Maintenance Introduction

Hextronics Atlas300 and DJI Matrice 300 drone, as deployed as part of a larger fleet, are subject to wear and tear from normal use. This maintenance/inspection manual is designed to extend and conserve the lifespan of the products in use. This maintenance/inspection manual does not promise or guarantee the products to be free from defects, damages, and errors.

This checklist is designed to suit the needs of routine maintenance check-ups and can be applied as frequently as necessary, but it is most efficient to perform maintenance on a per-flight basis, rather than a set time frame.

Proper operation, scheduling and maintenance of the drone & the station will result in increasing the lifespan and longevity of both the station and the drone. Regularly perform the inspections to ensure all systems are in working order and that any repairs or replacements can be addressed before the next flight.

Check that you have the following equipment on hand before maintaining the drone and the station: Anti-static cloth, small cleaning brush (for tight crevices), Compressed air canister (air duster), Anti-static wristband Electrical Contact Cleaner.

CAUTION Always use protective equipment when handling, maintaining, inspecting or in contact with any Hextronics or DJI components. Drone stations and DJI drones are composed of various electrical and mechanical moving parts and may cause harm if not handled properly, confirm that all components and devices are disconnected from power and not in operation when handling, operating, maintaining, inspecting or servicing any Hextronics or DJI devices. Protective equipment may consist of but is not limited to closed toed rubber shoes (for electrical grounding in order to prevent electric shock). Protective gloves also include electrical insulated gloves to avoid risk of injury to the hands including cuts, scraps, shocks, etc. Also, it is highly advised to use eye protective equipment such as impact resistance goggles or impact resistance glasses in order to protect the users' eyes from injury at anytime of operation, handling, maintaining, servicing, repair or inspection. Consult with the Hextronics support team or the DJI support team before initiating any inspection, maintenance, servicing, operation, handling etc if you have any questions, concerns or doubts in the email below.

Support@Hextronics.Tech

Station Maintenance

This section is dedicated to regular maintenance of the Global Advanced drone station in its entirety. Please perform these inspections periodically, but ideally every 3 months.

Confirm station is positioned on a flat, leveled, and elevated surface

Confirm that the entirety of the station is placed on a flat, level and dry **OUTDOOR** working area off the ground for best internal operational movements and precision landing of the drone. An Industrial leveler can be used as a tool to verify the positioning. Confirm that there is no overhead obstructions such as tree branches or other structures.

Interior visual inspection

Visually inspect the physical condition of the station from the interior. Monitor any abnormalities inside the station such as unknown damages, stains, or debris as well as watermarks or any deformation of the silver-coated insulation inside the station. Carefully clean the station interior section if necessary. Be sure to use caution when dealing with sensitive electronic components and do NOT use water inside the station. The cooling fan also should be cleaned frequently to maintain proper temperature and ventilation.

Landing pad

The landing pad should be cleaned periodically. The precision landing QR codes along with the AR- tag should be in good form to allow the Precision Landing process to run smoothly. Inspect the health of the QR stickers routinely.

Confirm that the internal pad Aruco marker is in good condition without any damage to the design of the tag. Clean with a moist towel but do not leave any wet puddles on the pad.

Check power supply connection

Make sure the power cable connection and socket at both ends (station-power source) are intact and perfectly secured to avoid short circuits due to weather exposure during operation. Clean the male and female conductor point with contact cleaner if necessary and confirm that the prongs are in good condition without damage or debris.

Check Ethernet connectivity

Ethernet LAN connection is one of the most important things for this Hextronics stationed Drone operation. Making sure the functionality of this connection is mandatory to allow data transfer processes to run smoothly. Inspect male and female connection points frequently.

Inspect the cooler compartment and ventilation.

Make sure there is no obstruction in the HVAC compartment. Clean the ventilator section thoroughly using a cleaning brush or anti-static cloth. Verify that the fan is blowing cold air. Open the service panel to access the Micro AC component inside the case and use compressed air to remove any debris.

Carefully place your hand over the internal fan and confirm that the fan is blowing cold air when the cooler is enabled. Confirm that the fan is spinning and producing sufficient air flow when powered on. The fan works independently from the compressor, so you can also verify that the air being blown from the fan is cold to verify the compressor system.

Check the state of wiring and components

Reference the wiring orientation according to the wiring diagram. Look for visibly damaged points and make sure no cable is loose or hanging. Please contact the Hextronics Support team if you detect any defective wiring. The below listed components should be securely fixed and connected within the station. Please see the component diagram to reference individual parts.

Drone RC, Raspberry Pi, Odroid N2 Flight CPU, Battery chargers, Battery PCBs, Cooling Fan, Ethernet LAN switch Box, 24V Power Supply Box, Hexboard, PTC Resistive Heater Climate Control Relays, Compressor Control PCB, Evaporator AC Coil.

Inspect antenna

Check the physical omni-directional antennas. Make sure both antennas are in good condition and the underside connections are securely tightened. Clean the connection point if necessary using the contact cleaner and remove the antenna during any relocating process.

Check battery charger slots

Examine each battery charging slot carefully. There should be no debris or obstruction inside the charging docks as it has been shaped precisely according to the drone battery dimension. Perform visual inspection of the charging slots and clean the area if necessary, using a vacuum, contact cleaner or anti-static cloth.

Individually confirm that each battery slot tray is in good condition with no damage, and that the internal charging connector is straight and not missing any pins and that the pin housing is not bent or deformed in any way. Also, confirm that batteries are inserted smoothly into the slots during battery swap operations.

Inspect mechanical parts to operate with no obstruction

The mechanical moving parts must be individually inspected to confirm there are no obstructions and that the components move smoothly. Clean and grease the area if necessary by referencing the maintenance module timeline to prevent metal-on-metal wear & damage.

Weather resistance seals

The weather seals are responsible for maintaining a dry interior of the station, any moisture or humidity within the station is likely to result in electrical & hardware malfunctions. Please confirm that the weather seals are in good condition and cover the entirety of the designated area.

Belt condition & tension on Landing Pad and Gantry

Proper belt tension is required for hardware operation movements to be successful. Manually inspect and squeeze each belt loop for any damages or missing teeth. The belts should be rigid and tight, loose belts should be addressed as soon as possible for proper station operations to continue.

Confirm that the belt teeth are orientated in towards the pulleys and on track, also inspect the integrity of the teeth to confirm there are no bald spots or missing teeth.

Maintenance Schedule

Recommended routine periodic routine maintenance checks on the drone station

| | Part | Maintenance Description | Maintenance Frequency |
|----|----------------------------------|--|-----------------------|
| 1 | Landing pad centering mechanisms | Add a very light layer of all-purpose grease to the centering mechanisms. Verify smooth translation of the centering mechanisms. | Every 3 months |
| 2 | Z Axis | Add a very light layer of all-purpose grease to the Z-axis vertical rods. | Every 3 months |
| 3 | Battery rack boards | Confirm that the battery rack boards on both sides have a secure connection. Confirm that batteries charge in all 8 slots. Confirm that the connection is secured in the rear of the battery boards. | Every 3 months |
| 4 | Landing platform | Confirm that the landing platform is parallel to the ground and level. Clean the top of the landing pad from dirt and debris. Inspect the landing pad for scuffs and scrapes. Confirm the landing pad clarity to observe the Aruco tag. Replace plastic on top of the pad if sufficiently damaged. | Every 3 months |
| 5 | Power cable | Confirm that the power cable is free of rust, debris, and damage at both ends. | Every 3 months |
| 6 | Power and ethernet port | Confirm that both the power and ethernet ports are free of rust, debris and damage and the ends are in good condition | Every 3 months |
| 7 | HVAC coils | <ol style="list-style-type: none"> 1. Unscrew HVAC panel screw 2. Remove panel 3. Use compressed air to blow out debris and clean HVAC coils | Every 3 months |
| 8 | Antenna mounts | Confirm that all three screws on each antenna mount are firm and secure (do not strip screws). Confirm that the antennas are tight and secure | Every 3 months |
| 9 | Gantry Z-axis belts | Confirm that the belt is not loose, that the belt is in the correct orientation with the teeth facing inward towards the pulleys, and that there are no missing teeth or ribs | Every 3 months |
| 10 | Landing pad Z-axis belts | Confirm that the belt is not loose, that the belt is in the correct orientation with the teeth facing inward towards the pulleys, and that there are no missing teeth or ribs | Every 3 months |
| 11 | Gripper | Confirm that the gripper is opening and closing correctly when prompted to | Every 3 months |
| 12 | Internal battery slots | Confirm that the battery slots are in good condition with no damage, and that the internal charging connector is | Every 3 months |

| | | | |
|----|--------------------------|---|----------------|
| | | straight and not missing any prongs and that the connector housing is not bent. Confirm that the battery indicators are illuminated when the batteries are inserted. Ensure proper connection of the battery cables to the boards in the battery rack. | |
| 13 | Internal battery charger | Inspect that all connections on the internal battery pack are secure and not deformed in any way. Confirm that the battery indicators are illuminated when the batteries are inserted. Ensure proper connection of the battery cables to the battery charger. | Every 3 months |
| 14 | HVAC fan | Carefully place your hand over the internal fan and confirm that the fan is blowing air, and cold air when the cooler is enabled. | Every 3 months |
| 15 | Stepper motors | Confirm that all stepper motors are in good condition and without rust, and that the motor is powering on when prompted. | Every 3 months |
| 16 | DC motors | Confirm that all DC motors are in good condition and without rust, and that the motor is powering on when prompted. | Every 3 months |
| 17 | Z-axis motor | Confirm that the Z-axis motor is in good condition and without rust, and that the motor is powering on when prompted. | Every 3 months |
| 18 | Aruco marker | Confirm that the Aruco marker is in good condition without any damage to the design of the tag. | Every 3 months |
| 19 | Weather station seal | Confirm that the weather seals are in good condition and seal the station when closed. This includes the front station seal and the back panel access seals. | Every 3 months |

Drone Maintenance

Use the resources below in order to maintain your DJI M300 drone









DJI M300 Official Maintenance link

https://dl.djicdn.com/downloads/matrice-300/20200507/M300_RTK_Maintenance_Manual_v1.0_EN.pdf

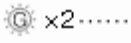
LED Indicator chart

The M300 drone features front LED aircraft status Indicator lights. Below is a diagram with the position of the LED lights on the aircraft & a description of each light pattern.

⚠ If any WARNING indications are made during flight operations - Immediately cease flight, safely land the drone, and contact support.

| Normal | | |
|---|-------------------------------------|---|
|  | Red, green, and yellow flashes | Turning On and Self Diagnostic Testing |
|  | Slow green flashing | P-mode with GNSS positioning* |
|  | Two green flashes | P-mode with Vision Systems* |
|  | Alternating green and blue flashing | The RTK function is enabled and RTK data is used. |
|  | Slow yellow flashing | A-mode (no GPS and vision positioning) |
|  | Fast green flashing | Braking automatically after obstacle detected |
| Warning | | |
|  | Fast yellow flashing | Remote Controller Signal Lost |
|  | Slow red flashing | Low Battery Warning |
|  | Fast red flashing | Critical Low Battery Warning |

Drone Calibration

Only calibrate the compass if the DJI pilot APP instructs you to do so. Follow the guidelines below for a proper compass calibration process.

⚠ Do not calibrate the compass if there is a strong magnetic field such as a parking structure, structural buildings, powerlines or antennas. Make sure not to carry any items that may cause electromagnetic interference, such as cellphones or smart watches. The DJI pilot app will notify you in the case of magnetic interference.

Calibration process

1. Download and open the DJI pilot app, select the aircraft status bar, then select calibrate. From this point please follow the app instructions for the compass calibration process.
2. When prompted on the DJI pilot app, hold the aircraft horizontally as seen in the diagram below and rotate it 360 degrees on its axis. The aircraft LED indicators go solid green when done correctly and red if incorrectly.
3. When prompted by the DJI pilot app, hold the aircraft vertically as seen in the diagram below, and rotate it 360 degrees on its center axis. Re attempt if the LED indicator is blinking red.

Note: If your aircraft blinks red & yellow after completing the calibration process please change locations and try again, it is likely that the calibration process was not successful due to magnetic interference interrupting the calibration process.

Vision Sensor Calibration

The Vision System cameras installed on the aircraft are factory calibrated. If the aircraft experiences a collision or the working temperature has changed significantly, it may require calibration to the Vision System via the DJI assistant 2 APP for the Matrice series.

Connect the aircraft to a computer and calibrate the Vision System cameras when prompted in the DJI Pilot App.

1. Power on the aircraft
2. Connect the aircraft and the PC with a USB-C cable (See Image 1A)
3. Launch the DJI Assistant 2 for Matrice and log in with a DJI account.
4. Click M300 RTK and then select the calibration button.
5. Place the side of the visual calibration plate with the dots facing the Vision System, and follow the instructions in the DJI assistant 2 to complete the calibration process.

NOTE: Do NOT power off or unplug the USB-C cable during calibration. Wait for the data calculation to be completed.

HVAC LED Code Troubleshooting

In the event of an HVAC error, please verify the number of LED flashes on the HVAC board as seen below, and compare the number of flashes to the chart below for a description of the error.

| LED Flashes | Error | Description |
|-------------|------------------------------|---|
| 1 | Short or output over-current | <p>The driver will alarm over current failure when the peak value of output current is larger than 30A, and stop the output.</p> <p>The driver will restart in 3 mins. The driver will lock if there are more than 7 times the current within 1 hour.</p> |
| 2 | Motor stall | <p>The motor will stop the output and alarm if the motor stalls.</p> <p>The driver will attempt to run after 3 minutes.</p> |
| 3 | Temperature sensor failure | The driver will shut off if the temp tensor is not detected. |
| 4 | MOSFET over temperature | <p>Stop the output if the MOSFET temp reaches 105°C</p> <p>Will restart when the temp of PIM reduces to 85°C</p> <p>If over temp is detected the driver will stop and re-attempt after 3 minutes.</p> |
| 5 | V_BUS low voltage | The driver will alarm and stop the output if detected under 19v and will restore when output is over 20v for over 3 minutes |
| 6 | V_BUS over voltage | The driver will alarm and stop the output when V_BUS is higher than 33v and will restore when V_BUS is lower than 32v and last more than 3 minutes. |
| 7 | Lack phase | The driver will alarm and stop the output if disconnecting between the driver and the compressor. The drive will re-attempt after 3 minutes. |

Station Battery Rack Lights/Sound Indicators

If a hardware error warning is detected please contact Support@hextronics.tech for assistance

Buzzer Beeping Description

Buzzer beeping is used to indicate errors as outlined below.

1. When the Battery Status LED is red, the buzzer is beeping to indicate a battery error.
2. When the Warning LED is red, the buzzer is beeping to indicate a Battery Station hardware error.

| LED Indicators | Descriptions |
|----------------------------|---|
| Power Indicator | |
| Solid green | Powered on |
| Battery Status LEDs | |
| Solid green | Charging completed |
| Blinks green | Charging |
| Solid yellow | Waiting for charging |
| Blinks yellow | Warming up before charging |
| Blinks yellow twice | Cooling down before charging |
| Blinks yellow three times | Cannot charge the battery due to very low temperature Please charge the battery in a place of higher temperature |
| Solid red | Battery error* |
| Blinks red | Battery communication warning, please try other battery ports |
| Blinks red twice | Battery short circuit, please try other battery ports |
| Warning LED | |
| Blinks yellow | Battery Station is updating |
| Solid yellow | The input voltage is too low. Please use the power supply that meets the requirements |
| Blinks red | Power module communication error or other* |
| Blinks red twice | Motherboard error* |
| Blinks red three times | Fan error* |
| Blinks red four times | Battery Station self-test error* |

* = Please contact your local dealer or a representative from the DJI after-sales team.

Notes:

- For TB60 Intelligent Flight Batteries, the Battery Station will charge the two batteries with the most amount of remaining battery power first. For example, if there are four TB60 batteries plugged into the Battery Station (the first two batteries having more battery left than the second two), the Battery Station will automatically charge the first two batteries first.
- For WB37 Batteries, the Battery Station will charge the battery with the highest remaining battery power first
- When the temperature of the battery is too low, it will warm up automatically before charging.

Troubleshooting & Repair

This section describes the troubleshooting and repair process for the Atlas

Atlas Troubleshooting and Repair Introduction

The Atlas is a complex product that relies on various mechanical, electrical, and electronic components to operate correctly. While the product is designed and manufactured to the highest standards, it's inevitable that issues will arise from time to time. That's why we've created this Troubleshooting & Repair guide for the Atlas, providing a comprehensive resource for diagnosing and resolving issues with the product. In this guide, we've included detailed information on common problems that users may encounter with the Atlas, along with step-by-step instructions for troubleshooting and repairing those issues. From simple mechanical problems to complex electrical issues, this guide covers it all, providing you with the knowledge and skills needed to get your Atlas up and running again in no time. Whether you're a professional technician or a novice user, this Troubleshooting & Repair guide will prove invaluable in helping you keep your Atlas in top condition.

Troubleshooting: Hardware/Software

 *This section is intended for troubleshooting movement errors ONLY.*

1. **Access the Hextronics Atlas Dashboard**
 - Access to the Control Panel by scanning the Hextronics provided QR Code within the **Accessories** folder, or by clicking the link within the welcome email.
 - The password is also in the "Welcome" email, and within the **Accessories** folder
 - If any operations were **unsuccessful** please contact support Support@hextronics.tech
2. **In the Atlas Commands Dashboard:**
 - Select **Open Roof**
 - Select **Raise Pad**
 - Select **Open Lat** and **Open Long** (if closed)
3. **Insert drone onto the landing pad**
 - The front gimbal of the drone **must** face away from the rear of the station
4. **In the Atlas Commands Dashboard:**
 - Select **Close Lat** and **Close Long**
 - Select **Lower Pad**
 - Select **Open Gripper** (if closed)
 - Select **Extra Command 3**
 - Select **Extra Command 4**
 - Select **Extra Command 5**
 - Select **Extra Command 6**
 - Select **Power Drone Toggle**
 - If any operations were unsuccessful please contact support Support@hextronics.tech
5. **Select Swap Batteries**

Warranty

This section includes the
Atlas warranty

Hextronics Atlas Drone Station

Manufacturer's Warranty

This Limited Warranty applies only to physical goods, and only for physical goods, purchased from Hextronics LLC. STANDARD ONE YEAR MANUFACTURER WARRANTY: The manufacturer warrants this product to be free from defects in workmanship and materials, under normal use and maintenance, for a period of one (1) year from date of purchase. Shipping and handling fees are to be paid by the customer. The manufacturer agrees, as its option during the warranty period:

- To repair and replace any defective components without charge (except for a fee for shipping, handling, packing, return postage, and insurance which will be incurred by the customer).
- Such repair or replacement is subject to verification of the defect or malfunction and proof of purchase as confirmed by showing the Record of Purchase form with corresponding Model and Serial Number.

Manufacturer's Limitations

This warranty does not include:

- Any condition resulting from other than ordinary residential wear or any use for which the product was not intended, such as use in rental or contract trade or commercial use
- Any condition resulting from incorrect or inadequate maintenance or care
- Damage resulting from misuse, abuse, negligence, accidents or shipping damage
- Dissatisfaction due to buyer's remorse
- Normal wear and tear
- Damages incurred during transportation
- Damages incurred during assembly or maintenance
- Any used, previously displayed items

The Company makes no express warranty or condition whether written or oral and the company expressly disclaims all warranties and conditions not stated in this limited warranty. To the extent allowed by the local law of jurisdictions outside the United States, the Company disclaims all implied warranties or conditions, including any implied warranties of merchantability and fitness for a particular purpose. For all transactions occurring in the United States, any implied warranty of condition of merchantability, satisfactory quality, or fitness for a particular purpose is limited to the duration of the express warranty set forth above. Some states or countries do not allow a limitation on how long an implied warranty lasts or the exclusion of limitation of incidental or consequential damages for consumer products. In such states or countries, some exclusions or limitations of this warranty may not apply to the Purchaser. For consumer transactions, the warranty terms contained in this statement, except to the extent lawfully permitted, do not exclude, restrict, or modify but are in addition to the mandatory statutory rights applicable to the sale of this Product to the Purchaser. All warranty claims must be filed by the consumer directly to the manufacturer. Please retain Record of Purchase for warranty purposes. CLAIM PROCEDURES:

- Claims for defective merchandise must be made within ONE year from the date of purchase. Claims for missing parts must be made within 60 calendar days after the merchandise is received
- Any claim for defective merchandise returns must be packaged in

original packaging • We reserve the right to specify that items be returned to the original warehouse for inspection or be inspected by our representative in the field • Pictures are required to claim defective merchandise, along with a Record of Purchase form. • If the claim is justified, the item(s) or part(s) will be repaired or replaced. It is our policy to replace parts whenever possible. This warranty gives you specific legal rights. You may have other rights, which vary from state to state.

Conclusion

This section concludes the Atlas User Manual

We hope that this user manual has provided you with all the necessary information to install, operate, and maintain your product successfully. Our goal is to ensure that your experience with our product is nothing short of exceptional, and we believe that this manual will help you achieve that. If you have any questions or concerns, please do not hesitate to contact our support team for assistance. Thank you for choosing our product, and we look forward to being a part of your success.

Thank you for using the Hextronics ATLAS Drone Station.

Please contact Support@Hextronics.Tech for assistance & support.